



# QUICK INDEX

Tool Storage .....	1-15
Hand Tools.....	16-36
Sockets.....	37-47
Vises & Clamps.....	48-51
Air Tools.....	52-62
Grease Tools .....	63-70
Electrical .....	71-77
Facility Maintenance .....	78-88
Packaging.....	89-94
Welding .....	95-103





The warranty and return policy stated and described below pertain to all products carrying the **Aurora Tools®** trademark. This warranty supersedes any and all manufacturer's warranties, written or implied. Our sole liability is limited to the repair or replacement of any product proven to be defective in material and/or workmanship and for which a warranty claim is made during the applicable warranty period. No claims for damages of any type will be allowed. All products are sold on this basis. Defective warranted products will be repaired or replaced at our sole discretion at no cost with a new or reconditioned product. This Warranty only applies when the product is used for the purpose for which it was originally designed, under normal operating conditions. This Warranty does not apply to products which have been abused, misused, modified or have been repaired by someone other than us. Discontinued warranted products will be replaced with products that are similar and available, or we will issue an appropriate credit. The specific warranty coverage for each product is as set out below. **Aurora Tools®** are only sold on a wholesale basis and accordingly, warranties only apply to purchasers for resale or for use in their business.

## One-Year Limited Warranty (Normal wear & tear expected)

- Air Tools & Accessories
- Bench Vises
- Clamps (bent or broken handles void warranty)
- Extension Cords
- Glue Guns
- Hand Pads
- Hex Key Sets
- Hose Reels (hose upon our inspection)
- Landscaping Tools
- Lubricating Equipment
- Multi-Tools
- Precision Measuring Tools
- Staple Guns
- Steel Stamps
- Utility Knives
- Vacuums

When presented to us within one (1) year from the invoice date of the original purchase, we will repair the defective product or will replace it, at our discretion.

## Lifetime Warranty (Normal wear & tear expected) This warranty applies to all the **Aurora Tools®** products listed herein:

- Adjustable Wrenches (snipe or hammer marks void warranty)
- Bolt Cutters (excluding jaws)
- Combination Wrenches (snipe or hammer marks void warranty)
- Hammers (head only)
- Indestructible Hammers
- Pliers
- Punches & Chisels
- Pipe Wrenches (excluding jaws)
- Ratchet Bodies (snipe or hammer marks void warranty – Bent or broken handles void warranty)
- Screwdrivers (hammer marks or bent shafts void warranty)
- Sockets & Accessories

## Tool Boxes

- ATB100 Series Steel Tool boxes – One Year Warranty
- ATB200 Series Steel Tool Boxes – Seven Year Warranty
- ATB300 Series Steel Tool boxes – Five Year Warranty
- ATB400 Series Steel Tool Boxes – Seven Year Warranty
- ATB500 Series Steel Tool Boxes – Five Year Warranty
- ATB600 Series Steel Tool Boxes – Lifetime Warranty
- Utility Boxes & Carts – One Year Warranty
- Road Chests – One Year Warranty
- Plastic Tool Boxes – One Year Warranty

This warranty does not cover products that are damaged through misuse, abuse, overloading, mishandling, accident, modification, neglect, or exposure to environmental factors. The only products expressly warranted for use in vehicles are the TEP500 and TEP501 provided they are mounted correctly in the vehicle with the provided rubber feet. All other claims for boxes used in a vehicle may be rejected. Ultraviolet rays and certain chemicals may also have an adverse effect upon paint finishes. Additives and UV inhibitors are included in the paint mix, but we cannot fully warrant against fading or blemish if exposed to the above conditions.

## Return Policy

Please return the COMPLETE tool, freight prepaid, to the **Aurora Tools®** Distributor where you purchased the product. If you have any questions, please contact your authorized **Aurora Tools®** Distributor (proof of purchase is required). This Warranty shall be governed by and interpreted in accordance with the laws of Quebec and the laws of Canada applicable therein.

# TOOL STORAGE

Steel Tool Boxes .....	2-5, 8
Utility Boxes .....	6
Plastic Tool Boxes.....	7
Tool Kits.....	9-15

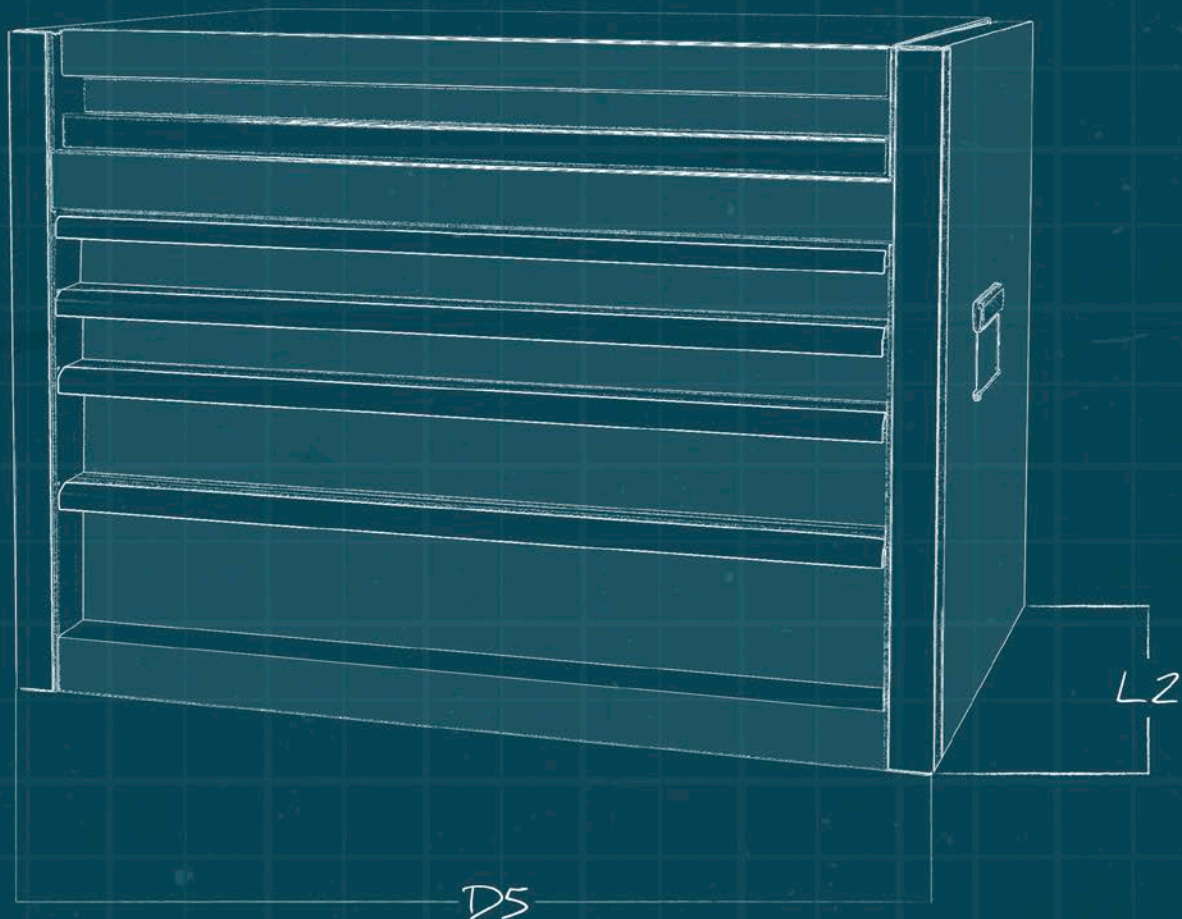



# STEEL TOOL BOXES

TOOL STORAGE

## ATB300 TOOL BOXES

- Double wall steel construction for added strength
- Full extension ball bearings slides on all drawers
- Extruded aluminum drawer handle trim
- Gas struts are in the lid of 56" & 42" wide chest for ease of opening and closing
- Non-slip drawer liners
- High gloss powder coat scratch resistant paint



TEP312



TEP314

**5** YEAR  
Limited Warranty



TEP315

Model No. Red	Blue	Black	No. of Drawers	Caster Size"	Dimensions W" x D" x H"	Drawer Cap. lbs.	Unit Cap. lbs.
<b>CHESTS</b>							
TEQ435	TEQ436	TEP312	4	-	26 x 12 x 14-3/8	100	375
TEQ437	TEQ438	TEP314	6	-	26 x 17-3/4 x 18-3/8	100	675
TEQ439	TEQ440	TEP316	10	-	40-5/8 x 18 x 18-1/8	100	1000
TEQ441	TEQ442	TEP318	6	-	55-1/8 x 23-5/8 x 18-1/4	100	720
<b>CARTS</b>							
TEQ443	TEQ444	TEP313	5	5 x 1-1/4	27 x 18-3/4 x 31-1/2	100	900
TEQ445	TEQ446	TEP315	7	5 x 1-1/4	27 x 18-3/4 x 35-7/8	100	900
TEQ447	TEQ448	TEP317	11	5 x 2	41-5/8 x 18-3/4 x 38-3/8	100	900
TEQ449	TEQ450	TEP319	10	5 x 2	56 x 24-1/2 x 38-1/8	100	1350

## SIDE CABINET FOR ATB300 TOOL BOXES

Model No. Red	Blue	Black	Description	Dimensions W" x D" x H"
TEQ471	TEQ472	TEP495	1-Shelf Side Cabinet	15-1/8 x 18-3/4 x 32-3/4
TEQ473	TEQ474	TEP496	2-Shelf Side Cabinet	15-3/8 x 18-3/4 x 49-1/4
TEQ475	TEQ476	TEP497	2-Shelf Side Cabinet	15-3/8 x 24-1/2 x 49-1/4

## ATB400 HEAVY-DUTY TOOL BOXES

- Heavy-duty double wall steel construction for added strength
- Quadra level ball bearing slides on all drawers
- Heavy-duty reinforced bottom support rails for heavier loads
- Full extension slides for easy reach inside
- Integrated latch security drawer system prevents drawers from accidentally opening
- Heavy-duty gas struts on top lid
- High-gloss powder coat scratch-resistant blue paint
- Includes non-slip drawer liners



TEP322

**LIFETIME**  
Limited Warranty



TEP323

Model No.	Red	Blue	Black	No. of Drawers	Caster Size"	Dimensions W" x D" x H"	Drawer Cap. lbs.	Unit Cap. lbs.
<b>CHESTS</b>								
TEQ451	TEP320	TEQ452	4	-	26-5/8 x 18 x 18-7/8	120	500	
TEQ453	TEP322	TEQ454	5	-	26-5/8 x 18 x 20	120	600	
TEQ455	TEP324	TEQ456	6	-	41 x 18 x 20	120	700	
TEQ457	TEP326	TEQ458	9	-	55-1/8 x 18 x 22-1/8	120	1000	
<b>CARTS</b>								
TEQ459	TEP321	TEQ460	5	5 x 2	27-1/8 x 18-3/4 x 35-7/8	120	900	
TEQ461	TEP323	TEQ462	7	5 x 2	27-1/8 x 18-3/4 x 42-3/8	120	900	
TEQ463	TEP325	TEQ464	14	5 x 2	41-5/8 x 18-3/4 x 42-3/8	120	900	
TEQ465	TEP327	TEQ466	13	5 x 2	53-5/8 x 18-3/4 x 40-1/4	120	1350	

## SIDE CABINET FOR ATB400 TOOL BOXES

Model No.	Red	Blue	Black	Description	Dimensions W" x D" x H"
TEQ471	TEQ472	TEP495	1-Shelf Side Cabinet	15-1/8 x 18-3/4 x 32-3/4	
TEQ473	TEQ474	TEP496	2-Shelf Side Cabinet	15-3/8 x 18-3/4 x 49-1/4	
TEQ475	TEQ476	TEP497	2-Shelf Side Cabinet	15-3/8 x 24-1/2 x 49-1/4	



# STEEL TOOL BOXES

TOOL STORAGE

## ATB500 TOOL BOXES

- Full extension ball bearing slides on all drawers
- Double wall steel construction
- High gloss powder coat scratch resistant paint
- Extruded aluminum drawer pulls
- Sturdy side handle



TEQ632



TEQ657

**5** YEAR  
Limited Warranty

Model No.	Red	Blue	Black	No. of Drawers	Caster Size"	Dimensions W" x D" x H"	Drawer Cap. lbs.	Unit Cap. lbs.
<b>CHESTS</b>								
TEQ620	TEQ622	TEQ621	3	-	26 x 12 x 14-3/8	75	250	
TEQ626	TEQ628	TEQ627	9	-	26 x 18 x 20-1/4	75	400	
TEQ623	TEQ625	TEQ624	3	-	27 x 18-3/4 x 18-3/8	75	250	
TEQ629	TEQ631	TEQ630	4	-	40-1/2 x 18 x 18-1/4	75	500	
TEQ632	TEQ634	TEQ633	7	-	40-1/2 x 18 x 18-1/8	75	500	
TEQ635	TEQ637	TEQ636	7	-	52-1/2 x 17-7/8 x 18-3/8	75	500	
<b>CARTS</b>								
TEQ507	TEQ642	TEQ641	3	5 x 1-1/4	27 x 18-3/4 x 35-3/4	75	550	
TEQ508	TEQ644	TEQ643	5	5 x 1-1/4	27 x 18-3/4 x 36	75	900	
TEQ638	TEQ640	TEQ639	3	4 x 1	27 x 18-3/4 x 30-3/8	75	550	
TEQ645	TEQ647	TEQ646	9	5 x 1-1/4	27 x 18-3/4 x 42-3/8	75	900	
TEQ648	TEQ650	TEQ649	5	5 x 2	41-1/2 x 18-3/4 x 38	75	900	
TEQ651	TEQ653	TEQ652	9	5 x 2	41-1/2 x 18-3/4 x 38	75	900	
TEQ654	TEQ656	TEQ655	10	5 x 2	53-1/2 x 18-3/4 x 38	75	900	
TEQ657	TEQ659	TEQ658	11	6 x 2	72-3/4 x 18-3/4 x 39-1/8	75	900	

## ATB600 TOOL BOXES

- Includes pre-cut, anti-skid drawer liners
- Features 4 protective aluminum corners
- High-security lock
- Safe-Lock drawer system prevents drawers from accidentally opening
- Two pairs of 120-lb rated ball bearing slides on all drawers over 3" deep
- Three layers of metal reinforce the corners with new interlock corner design
- Rigidity of frame is significantly increased with full height & width triple channel inner wall
- Drawers made of 20-gauge steel and are fully-extendable for easy reach-inside
- Frame is reinforced using 14-gauge plates on the bottom of the cabinet



**LIFETIME**  
Limited Warranty



Model No.			No. of Drawers	Dimensions W" x D" x H"	Drawer Cap. lbs.	Unit Cap. lbs.	Top Material
Red	Blue	Black					
<b>CHESTS</b>							
TEQ729	TEQ731	TEQ730	5	27-1/8 x 18-3/4 x 22-3/4	120	600	-
TEQ732	TEQ733	TEQ734	5	35 x 18-3/4 x 22-3/4	120	600	-
TEQ738	TEQ740	TEQ739	4	41-1/2 x 24-1/2 x 22-1/4	120	480	-
<b>CARTS</b>							
TEQ744	TEQ746	TEQ745	6	27 x 18-3/4 x 42-1/8	120	3500	MDF
TEQ747	TEQ749	TEQ748	6	35 x 18-5/8 x 42-1/8	120	3500	MDF
TEQ750	TEQ752	TEQ751	5	41-1/2 x 24-1/2 x 42	120	3500	Stainless Steel
TEQ753	TEQ755	TEQ754	12	53-1/2 x 24-1/2 x 43-3/8	120	5000	Stainless Steel
TEQ758	TEQ760	TEQ759	12	53-1/2 x 24-1/2 x 43-3/8	120	5000	Wood
TEQ756	TEQ701	TEQ757	21	73 x 24-1/2 x 43-3/8	120	5000	Stainless Steel

## ATB600 TOOL BOX HUTCH

- High-security lock
- Gas cylinder helps to easily open the hutch lid
- Aluminum handle
- High-gloss, scratch-resistant powder coat paint
- Features inside pegboard wall

**LIFETIME**  
Limited Warranty



Model No.			Outside Wall & Door Material	Dimensions W" x D" x H"
Red	Blue	Black		
TEQ735	TEQ737	TEQ736	20-Gauge Steel	42 x 18-3/8 x 23-7/8
TEQ741	TEQ743	TEQ742	18-Gauge Steel	53-1/8 x 24-1/2 x 28-1/4



# UTILITY BOXES & CARTS

## DIAMOND PLATE UTILITY BOXES

- Heavy gauge steel construction
- Fully welded seams provide maximum strength
- Side handles facilitate transportation
- Black powder coat finish

TEP498



Model No.	Dimensions W" x D" x H"	Wt. lbs.
TEP498	30-1/2 x 13-1/2 x 10	15
TEP499	45-3/8 x 15-3/8 x 15-1/8	35

## UTILITY CARTS

- Heavy-duty steel construction
- Full extension ball bearing slides on all drawers
- High quality 4" swivel casters
- Drawer capacity: 100 lbs.
- Unit capacity: 550 lbs.
- High gloss powder coat scratch resistant black paint
- Assembly required

TEP502



Model No.	No. of Drawers	Dimensions W" x D" x H"	Wt. lbs.
TEP502	2	45-3/4 x 16-1/2 x 36	100
TEP483	4	37 x 18-3/8 x 40-1/2	95

TEP483



## HEAVY-DUTY TOOL BOXES

- ABS plastic latches are virtually indestructible
- Heavy-duty polypropylene construction
- Removable inner trays
- Deep storage compartments
- Padlock eye for safe storage

Model No.	Dimensions W" x D" x H"	Features
TLV082	15 x 7 x 5-1/2	1 Removable Inner Tray
TLV083	17-1/2 x 9-1/2 x 8	1 Removable Inner Tray
TLV084	17-1/2 x 9-1/2 x 8	1 Removable Inner Tray, 2 Parts Boxes, 1 Organizer
TLV085	22 x 11 x 10-1/2	1 Removable Inner Tray, 3 Organizers
TLV086	22 x 11 x 14-1/2	1 Removable Inner Tray, 3 Organizers, 2 Drawers



TLV082

TLZ117  
Parts Box



TLV083



TLV084



TLV085



TLV086



CF333

## COMPARTMENT CASE

- High strength, high quality polypropylene case
- Translucent lid allows for quick view of contents
- Snap latch ensures a secure closure
- Removable dividers allow for different configurations

Model No.	Dimensions W" x D" x H"	No. of Compartments
CF333	10-3/4 x 5-3/8 x 1-1/2	Variable up to 17
TLZ117	5-1/2 x 5-1/2 x 1-1/2	Variable up to 9



## ATB100 PORTABLE TOOL BOXES

- Durable steel construction
- Heavy-plated latches
- Inner trays in regular hand boxes
- High gloss powder coat paint

### 16" TOOL BOX WITH METAL TOOL TRAY

Model No. TEP516



### 21" TOOL BOX WITH METAL TOOL TRAY

Model No. TEP336



### 26" TOOL BOX WITH METAL TOOL TRAY

Model No. TEP337



### 20" HIP ROOF TOOL BOX WITH METAL TOOL TRAY

Model No. TEP338



### 21" CANTILEVER TOOL BOX

Model No. TEP339



### 21" 3-DRAWER CHEST

Model No. TEP340



Model No.	Description	Overall Dimensions W" x D" x H"	Wt. lbs.
TEP516	16" Tool Box w/ Metal Tool Tray	16 x 6 x 6-1/2	4.8
TEP336	21" Tool Box w/ Metal Tool Tray	21 x 8-3/4 x 9	12.5
TEP337	26" Tool Box w/ Metal Tool Tray	26 x 8-3/4 x 9	15
TEP338	20" Hip Roof Box w/ Metal Tool Tray	20 x 7 x 8	7
TEP339	21" Cantilever Tool Box	21 x 8-3/4 x 12	15
TEP340	21" Three Drawer Chest	21 x 8-3/4 x 12	20

## 17-PIECE BASIC TOOL SET

### SET INCLUDES:

- TLV083 Tool Box
- TJZ062 1/4" Slot Screwdriver, 5" Shank
- TJZ068 #2 Phillips Screwdriver, 4" Shank
- TJZ073 #2 Square Tip Screwdriver, 6" Shank
- TJZ033 Hammer, 16-oz. Claw
- TJZ079 Groove Joint Pliers, 8" L
- TJZ083 Diagonal Cutting Pliers, 5" L
- TJZ086 Long Nose Pliers, 6" L
- TJZ092 Locking Pliers, 7" L
- TJZ095 Long Nose Locking Pliers, 6" L
- TJZ117 Measuring Tape, 16' L
- PE549 Utility Knife
- TJZ102 Adjustable Combo Wrench, 10" L
- TJZ060 1/4" Stubby Slot Screwdriver, 1-1/2" Shank
- TJZ069 #2 Stubby Phillips Screwdriver, 1-1/2" Shank
- TJZ076 #2 Stubby Square Tip Screwdriver, 1-1/2" Shank
- TJZ075 #1 Stubby Square Tip Screwdriver, 1-1/2" Shank

Model No. TLV075



## 28-PIECE ESSENTIAL TOOL SET

### SET INCLUDES:

- TLV084 Tool Box
- TJZ072 #1 Square Screwdriver, 4" Shank
- TJZ073 #2 Square Screwdriver, 6" Shank
- TJZ067 #1 Phillips Screwdriver, 3-1/4" Shank
- TJZ068 #2 Phillips Screwdriver, 4" Shank
- TJZ062 1/4" Slot Screwdriver, 5" Shank
- TJZ064 5/16" Slot Screwdriver, 6" Shank
- TNB733 Hex Key Set, S.A.E.
- TJZ801 Measuring Tape, 1' W x 25' L, in/ft
- TJZ078 Slip Joint Pliers, 6" L
- TJZ083 Diagonal Cutting Pliers, 5" L
- TJZ086 Long Nose Pliers, 6" L
- TJZ091 Locking Pliers, 5" L
- TJZ095 Long Nose Locking Pliers, 6" L
- TJZ101 Adjustable Wrench, 8" L
- PE549 Utility Knife
- TJZ033 Hammer, 16 oz.
- TJZ036 Dead Blow Hammer, 16 oz.
- TJZ040 Ball Pein Hammer, 16 oz.
- TJZ043 Rubber Mallet, 16 oz.

Model No. TYP013







## 118-PIECE PROFESSIONAL TOOL SET

### SET INCLUDES:

TLV086	Tool Box	TNB732	Metric Hex Key Set
PE812	Utility Knife	TJZ057	1/8" Slot Screwdriver, 3" Shank
TYW991	Hacksaw	TJZ058	3/16" Slot Screwdriver, 3" Shank
TJZ033	Hammer, 16 oz.	TJZ060	1/4" Stubby Slot Screwdriver 1-1/2" Shank
TJZ041	Ball Pein Hammer, 24 oz.	TJZ061	1/4" Slot Screwdriver, 4" Shank
TJZ047	Action Bar, 13-1/2" L	TJZ064	5/16" Slot Screwdriver, 6" Shank
TJZ078	Split Joint Pliers, 6-1/2" L	TJZ065	3/8" Slot Screwdriver, 8" Shank
TJZ080	Groove Joint Pliers, 10" L	TJZ066	#0 Phillips Screwdriver, 2-1/2" Shank
TJZ084	Diagonal Cutting Pliers, 7" L	TJZ067	#1 Phillips Screwdriver, 3-1/4" Shank
TJZ087	Long Nose Pliers, 8" L	TJZ068	#2 Phillips Screwdriver, 4" Shank
TJZ089	Linesman Pliers, 8" L	TJZ069	#2 Stubby Phillips Screwdriver, 1-1/2" Shank
TJZ093	Locking Pliers, 10" L	TJZ070	#3 Phillips Screwdriver, 6" Shank
TJZ095	Long Nose Locking Pliers, 6" L	TJZ071	#0 Square Tip Screwdriver, 4" Shank
TJZ102	Adjustable Wrench, 10" L	TJZ072	#1 Square Tip Screwdriver, 4" Shank
TJZ801	Measuring Tape, 25' L	TJZ073	#2 Square Tip Screwdriver, 6" Shank
TLV053	S.A.E. Combo Wrench Set	TJZ074	#3 Square Tip Screwdriver, 6" Shank
TLV054	Metric Wrench Set	TJZ076	#2 Stubby Square Tip Screwdriver, 1-1/2" Shank
TLV357	24-pc. S.A.E. Socket Set	SAJ023	Work Gloves
TLV358	24-pc. Metric Socket Set	SAP877	Glasses
TJZ861	Caliper		
TNB731	S.A.E. Hex Key Set		

Model No. TLZ460



## 112-PIECE INTERMEDIATE TOOL SET WITH CART

### SET INCLUDES:

- TEP315 ATB300 Tool Cart, 7 Drawer, 27" x 18" x 35-1/2"
- TJZ057 Screwdriver, Slot Cabinet, 1/8" Tip, 3" Shank
- TJZ058 Screwdriver, Slot Cabinet, 3/16" Tip, 4" Shank
- TJZ060 Screwdriver, Slot Mechanics, 1/4" Tip, 1-1/2" Stubby Shank
- TJZ061 Screwdriver, Slot Mechanics, 1/4" Tip, 4" Shank
- TJZ064 Screwdriver, Slot Mechanics, 5/16" Tip, 8" Shank
- TJZ065 Screwdriver, Slot Mechanics, 3/8" Tip, 8" Shank
- TJZ066 Screwdriver, Phillips, #0 Tip, 2-1/2" Shank
- TJZ067 Screwdriver, Phillips, #1 Tip, 3-1/4" Shank
- TJZ068 Screwdriver, Phillips, #2 Tip, 4" Shank
- TJZ069 Screwdriver, Phillips, #2 Tip, 1-1/2" Stubby Shank
- TJZ070 Screwdriver, Phillips, #5 Tip, 6" Shank
- TJZ071 Screwdriver, Square, #0 Tip, 4" Shank
- TJZ072 Screwdriver, Square, #1 Tip, 4" Shank
- TJZ073 Screwdriver, Square, #2 Tip, 6" Shank
- TJZ074 Screwdriver, Square, #3 Tip, 6" Shank
- TJZ076 Screwdriver, Square, #2 Tip, 1-1/2" Stubby Shank
- TJZ078 Pliers, Slip Joint, 6" L
- TJZ079 Pliers, Groove Joint, 8" L
- TJZ082 Pliers, Diagonal Cutting, 5" L
- TJZ084 Pliers, Diagonal Cutting, 7" L
- TJZ085 Pliers, Long Nose Cutting, 5" L
- TJZ087 Pliers, Long Nose Cutting, 8" L
- TJZ089 Pliers, Linesman Cutting, 8" L
- TJZ091 Locking Pliers, Curved Jaw w/ Wire Cutter, 5" L
- TJZ093 Locking Pliers, Curved Jaw w/ Wire Cutter, 10" L
- TJZ095 Locking Pliers, Long Nose w/ Wire Cutter, 6" L
- TJZ097 Locking Pliers, C-Clamps w/ Swivel Pads, 11" L

- TJZ100 Wrench, Adjustable, 6", w/ Composite Grip
- TJZ103 Wrench, Adjustable, 12", w/ Composite Grip
- TLV053 Wrench Set With Pouch, 11-pc. S.A.E.
- TLV054 Wrench Set With Pouch, 11-pc. Metric
- TNB751 Hex keys, S.A.E. Short Arm, 13 Keys, 0.05" - 3/8"
- TLV360 Socket Set, 41-pc., 1/4" & 3/8" Drive S.A.E./Metric
- TLZ396 Cold Chisel, 5/16" x 5" L
- TLZ398 Cold Chisel, 1/2" x 6" L
- TLZ400 Cold Chisel, 3/4" x 7" L
- TLZ417 Centre Punch, 5/32" x 5" L
- TLZ415 Centre Punch, 5/64" x 3-1/2" L
- TLZ419 Centre Punch, 3/8" x 6-1/4" L
- TLZ402 Pin Punch 3/32" x 4-1/2" L
- TLZ405 Pin Punch 3/16" x 5-1/4" L
- TLZ403 Pin Punch 1/8" x 4-3/4" L
- TYW991 Hacksaw Frame, Standard, Adjustable 10" - 12"
- TJZ047 Action Bar, 1-3/8" x 1/4" x 13-1/2"
- PE812 Utility Knife, H-D, w/ Auto Reload, Snap-off Blades
- TJZ033 Hammer, Claw, Hickory Handle, 16-oz.
- TJZ036 Hammer, Dead Blow, 16-oz.
- TJZ038 Hammer, Dead Blow, 32-oz.
- TJZ040 Hammer, Ball Pein, 16-oz.
- TJZ042 Hammer, Ball Pein, 32-oz.
- TJZ801 Measuring Tape, HD, 1" W x 25' L, in/ft, Composite Grip

Model No. TLV422





## 86-PIECE TRADESMAN TOOL SET

### SET INCLUDES:

- TLV086 Tool Box
- PE812 Utility Knife
- TYW991 Hacksaw
- TJZ033 Claw Hammer, 16 oz.
- TJZ036 Dead Blow Hammer, 16 oz.
- TNB731 Hex Keys, S.A.E., 0.05" - 3/8"
- TNB732 Hex Keys, Metric, 1.5 mm - 10 mm
- TJZ078 Split Joint Pliers, 6" L
- TJZ080 Groove Joint Pliers, 10" L
- TJZ084 Diagonal Cutting Pliers, 7" L
- TJZ087 Long Nose Pliers, 8" L
- TJZ089 Linesman Pliers, 8" L
- TJZ093 Locking Pliers, 10" L
- TJZ095 Long Nose Locking Pliers, 6" L
- TJZ102 Adjustable Combo Wrench, 10" L
- TJZ801 Measuring Tape, 25' L
- TJZ057 1/8" Slot Screwdriver, 3" Shank
- TJZ058 3/16" Slot Screwdriver, 4" Shank
- TJZ060 1/4" Stubby Slot Screwdriver, 1-1/2" Shank
- TJZ061 1/4" Slot Screwdriver, 4" Shank
- TJZ064 5/16" Slot Screwdriver, 6" Shank
- TJZ065 3/8" Slot Screwdriver, 8" Shank
- TJZ066 #0 Phillips Screwdriver, 2-1/2" Shank
- TJZ067 #1 Phillips Screwdriver, 3-1/4" Shank
- TJZ068 #2 Phillips Screwdriver, 4" Shank
- TJZ069 #2 Stubby Phillips Screwdriver, 1-1/2" Shank
- TJZ070 #3 Phillips Screwdriver, 6" Shank
- TJZ071 #0 Square Tip Screwdriver, 4" Shank
- TJZ072 #1 Square Tip Screwdriver, 4" Shank
- TJZ073 #2 Square Tip Screwdriver, 6" Shank

- TJZ074 #3 Square Tip Screwdriver, 6" Shank
  - TJZ076 #2 Stubby Square Tip Screwdriver, 1-1/2" Shank
  - TLV053 11-pc. S.A.E. Wrench Set
  - TLV357 20-pc. 3/8" S.A.E. Socket Set
  - SAJ023 Gloves
  - SAP877 Glasses
  - TJZ047 Action Bar, 13-1/2" L
- Model No. TLV076**



## 70-PIECE STARTER TOOL SET WITH STEEL CHEST

### SET INCLUDES:

- TEP312 ATB300 Tool Chest, 4 Drawer, 26" x 12" x 14-1/2"
- TJZ040 Hammer, Ball Pein, 16-oz.
- TJZ036 Hammer, Dead Blow, 16-oz.
- TJZ033 Hammer, Hickory Handle, Claw, 16-oz.
- TJZ078 Pliers, Slip Joint, Black Nickel Finish, 6" L
- TJZ079 Pliers, Groove Joint, 8" L
- TJZ084 Pliers, Diagonal Cutting, 7" L
- TJZ086 Pliers, Long Nose, Cutting, 6" L
- TJZ088 Pliers, Linesman Cutting, 7" L
- TJZ092 Locking Pliers, Curved Jaw w/ Wire Cutter, 7" L
- TLZ417 Centre Punch, 5/32" x 5" L
- TLZ418 Centre Punch, 1/4" x 6" L
- TLZ403 Pin Punch 1/8" x 4-3/4" L
- TLZ405 Pin Punch 3/16" x 5-1/4" L
- TLZ397 Cold Chisel, 3/8" x 5-1/2" L
- TLZ398 Cold Chisel, 1/2" x 6" L
- TLZ400 Cold Chisel, 3/4" x 7" L
- TLZ412 Drift Punch 1/4" x 12" L
- TJZ072 Screwdriver, Square, #1 Tip, 4" Shank
- TJZ073 Screwdriver, Square, #2 Tip, 6" Shank
- TJZ067 Screwdriver, Phillips, #1 Tip, 3-1/4" Shank
- TJZ068 Screwdriver, Phillips, #2 Tip, 4" Shank
- TJZ057 Screwdriver, Slot Cabinet, 1/8" Tip, 3" Shank
- TJZ061 Screwdriver, Slot Mechanics, 1/4" Tip, 4" Shank
- TJZ064 Screwdriver, Slot Mechanics, 5/16" Tip, 6" Shank
- TJZ101 Wrench, Adjustable, 8", Composite Grip
- TJZ103 Wrench, Adjustable, 12", Composite Grip
- TNB733 Hex Keys, S.A.E., Composite Grip Fold-up, 9 Keys
- TLV055 Wrench Set With Pouch, 14-pc. S.A.E.
- TLV357 Socket Set, 20-pc., 3/8" Drive S.A.E.

**Model No. TLV421**





## 238-PIECE MASTER TOOL SET WITH STEEL CHEST & CART

### SET INCLUDES:

- TEP314 ATB300 Tool Chest, 6 Drawer, 26" x 18" x 19"
- TEP315 ATB300 Tool Cart, 7 Drawer, 27" x 18" x 35-1/2"
- TJZ057 Screwdriver, Slot Cabinet, 1/8" Tip, 3" Shank
- TJZ058 Screwdriver, Slot Cabinet, 3/16" Tip, 4" Shank
- TJZ059 Screwdriver, Slot Cabinet, 3/16" Tip, 6" Shank
- TJZ060 Screwdriver, Slot Mechanics, 1/4" Tip, 1-1/2" Stubby shank
- TJZ061 Screwdriver, Slot Mechanics, 1/4" Tip, 4" Shank
- TJZ062 Screwdriver, Slot Mechanics, 1/4" Tip, 5" Shank
- TJZ063 Screwdriver, Slot Mechanics, 1/4" Tip, 6" Shank
- TJZ064 Screwdriver, Slot Mechanics, 5/16" Tip, 6" Shank
- TJZ065 Screwdriver, Slot Mechanics, 3/8" Tip, 8" Shank
- TJZ066 Screwdriver, Phillips, #0 Tip, 2-1/2" Shank
- TJZ067 Screwdriver, Phillips, #1 Tip, 3-1/4" Shank
- TJZ068 Screwdriver, Phillips, #2 Tip, 4" Shank
- TJZ069 Screwdriver, Phillips, #2 Tip, 1-1/2" Stubby Shank
- TJZ070 Screwdriver, Phillips, #3 Tip, 6" Shank
- TJZ071 Screwdriver, Square, #0 Tip, 4" Shank
- TJZ072 Screwdriver, Square, #1 Tip, 4" Shank
- TJZ073 Screwdriver, Square, #2 Tip, 6" Shank
- TJZ074 Screwdriver, Square, #3 Tip, 6" Shank
- TJZ075 Screwdriver, Square, #1 Tip, 1-1/2" Stubby Shank
- TJZ076 Screwdriver, Square, #2 Tip, 1-1/2" Stubby Shank
- TJZ077 Screwdriver, Square, #3 Tip, 1-1/2" Stubby Shank
- TJZ078 Pliers, Slip Joint, 6" L
- TJZ079 Pliers, Groove Joint, 8" L
- TJZ080 Pliers, Groove Joint, 10" L
- TJZ082 Pliers, Diagonal Cutting, 5" L
- TJZ083 Pliers, Diagonal Cutting, 6" L
- TJZ084 Pliers, Diagonal Cutting, 7" L
- TJZ085 Pliers, Long Nose Cutting, 5" L
- TJZ086 Pliers, Long Nose Cutting, 6" L
- TJZ087 Pliers, Long Nose Cutting, 8" L
- TJZ088 Pliers, Linesman Cutting, 7" L
- TJZ089 Pliers, Linesman Cutting, 8" L
- TJZ090 Locking Pliers, Curved Jaw w/ Wire Cutter, 4" L
- TJZ091 Locking Pliers, Curved Jaw w/ Wire Cutter, 5" L
- TJZ092 Locking Pliers, Curved Jaw w/ Wire Cutter, 7" L
- TJZ093 Locking Pliers, Curved Jaw w/ Wire Cutter, 10" L
- TJZ094 Locking Pliers, Long Nose w/ Wire Cutter 4" L
- TJZ095 Locking Pliers, Long Nose w/ Wire Cutter, 6" L
- TJZ096 Locking Pliers, C-Clamps w/ Swivel Pads, 6" L
- TJZ097 Locking Pliers, C-Clamps w/ Swivel Pads, 11" L
- TJZ100 Wrench, Adjustable, 6" L, w/ Composite Grip
- TJZ101 Wrench, Adjustable, 8" L, w/ Composite Grip
- TJZ102 Wrench, Adjustable, 10" L, w/ Composite Grip
- TJZ103 Wrench, Adjustable, 12" L, w/ Composite Grip
- TJZ104 Wrench, Adjustable, 15" L
- TJZ105 Wrench, Adjustable, 18" L
- TJZ108 Wrench, Straight Pipe, 12" L, 2" Pipe Capacity
- TLV055 Wrench Set With Pouch, 14-pc. S.A.E.
- TLV056 Wrench Set With Pouch, 14-pc. Metric
- TJZ356 Socket Set, 22-pc., 1/4" Drive S.A.E.
- TLV357 Socket Set, 20-pc., 3/8" Drive S.A.E.
- TLV358 Socket Set, 24-pc., 3/8" Drive Metric
- TLV359 Socket Set, 29-pc., 1/2" Drive S.A.E./Metric
- TLZ420 Cold Chisel Set, 6-pc.
- TLZ421 Pin Punch Set, 7-pc.
- TLZ422 Draft Punch Set, 7-pc.
- TLZ423 Centre punch Set, 5-pc.
- TYW991 Hacksaw Frame, Standard, Adjustable 10" - 12"
- TJZ047 Action Bar, 13-1/2" L
- PE812 Utility Knife, H-D, w/ Auto Reload, Snap-off Blades
- TJZ033 Hammer, Hickory Handle, Claw, 16-oz.
- TJZ034 Hammer, Hickory Handle, Framing, 22-oz.
- TJZ035 Hammer, Dead Blow, 8-oz.
- TJZ036 Hammer, Dead Blow, 16-oz.
- TJZ037 Hammer, Dead Blow, 24-oz.
- TJZ038 Hammer, Dead Blow, 32-oz.
- TJZ039 Hammer, Ball Pein, 8-oz.
- TJZ040 Hammer, Ball Pein, 16-oz.
- TJZ041 Hammer, Ball Pein, 24-oz.
- TJZ042 Hammer, Ball Pein, 32-oz.
- TJZ043 Mallet, Black, 16-oz.
- TJZ044 Mallet, Black, 32-oz.
- TNB751 Hex Keys, S.A.E. Short Arm, 13 Keys, 0.050" - 3/8"
- TNB752 Hex keys, Metric Short Arm, 9 Keys, 1.5 mm - 10 mm
- TJZ801 Measuring Tape, HD, 1" W x 25' L, in/ft, Composite Grip
- TJZ802 Measuring Tape, HD, 1" W x 25' L, in/cm, Composite Grip
- TJZ861 Digital Caliper, Stainless Steel, 8" L
- AD084 Mini Grease Gun, Push Type, 80 CC

Model No. TLV423



Looking for a tool... Look no further.  
This ultimate set includes most of the  
items you will find in this catalogue.

## 360 PIECE ULTIMATE TOOL SET



Model No. TY0941



### SET INCLUDES:

<b>TEP324</b>	ATB400 Tool Chest, 6 Drawers	<b>TJZ062</b>	1/4" Slot Screwdriver, 5" Shank	<b>TJZ094</b>	Long Nose Pliers, 4" L
<b>TEP325</b>	ATB400 Tool Cart, 14 Drawers	<b>TJZ063</b>	1/4" Slot Screwdriver, 6" Shank	<b>TJZ095</b>	Long Nose Pliers, 6" L
<b>AC509</b>	Grease Fitting Set	<b>TJZ064</b>	5/16" Slot Screwdriver, 6" Shank	<b>TJZ096</b>	Locking Pliers, C-clamp, 6" L
<b>AD084</b>	Grease Gun	<b>TJZ065</b>	3/8" Slot Screwdriver, 8" Shank	<b>TJZ097</b>	Locking Pliers, C-clamp, 11" L
<b>PE406</b>	Replacement Blades	<b>TJZ066</b>	#0 Phillips Screwdriver, 2-1/2" Shank	<b>TJZ099</b>	Locking Pliers, Sheet Metal, 8" L
<b>PE812</b>	Utility Knife	<b>TJZ067</b>	#1 Phillips Screwdriver, 3-1/4" Shank	<b>TJZ100</b>	Adjustable Wrench, 6" L
<b>THZ769</b>	Caliper	<b>TJZ068</b>	#2 Phillips Screwdriver, 4" Shank	<b>TJZ101</b>	Adjustable Wrench, 8" L
<b>IA388</b>	Micrometer	<b>TJZ069</b>	#2 Phillips Stubby Screwdriver, 1-1/2" Shank	<b>TJZ102</b>	Adjustable Wrench, 10" L
<b>TJZ801</b>	Measuring Tape, 1" W x 25' L in/ft	<b>TJZ070</b>	#3 Phillips Screwdriver, 6" Shank	<b>TJZ103</b>	Adjustable Wrench, 12" L
<b>TJZ802</b>	Measuring Tape, 1" W x 25' L in/cm	<b>TJZ071</b>	#0 Square Screwdriver, 4" Shank	<b>TJZ104</b>	Adjustable Wrench, 15" L
<b>TYW991</b>	Hacksaw	<b>TJZ072</b>	#1 Square Screwdriver, 4" Shank	<b>TJZ105</b>	Adjustable Wrench, 18" L
<b>TJZ033</b>	Claw Hammer, 16 oz.	<b>TJZ073</b>	#2 Square Screwdriver, 6" Shank	<b>TJZ108</b>	Pipe Wrench, 12" L
<b>TJZ034</b>	Claw Hammer, 22 oz.	<b>TJZ074</b>	#3 Square Screwdriver, 6" Shank	<b>TJZ110</b>	Pipe Wrench, 18" L
<b>TJZ035</b>	Dead Blow Hammer, 8 oz.	<b>TJZ075</b>	#1 Square Stubby Screwdriver, 1-1/2" Shank	<b>TLV055</b>	Combination Wrench Set, S.A.E.
<b>TJZ036</b>	Dead Blow Hammer, 16 oz.	<b>TJZ076</b>	#2 Square Stubby Screwdriver, 1-1/2" Shank	<b>TLV056</b>	Combination Wrench Set, Metric
<b>TJZ037</b>	Dead Blow Hammer, 24 oz.	<b>TJZ077</b>	#3 Square Stubby Screwdriver, 1-1/2" Shank	<b>TJZ112</b>	Bolt Cutters
<b>TJZ038</b>	Dead Blow Hammer, 32 oz.	<b>TJZ078</b>	Slip Joint Pliers, 6" L	<b>TLV361</b>	Socket Set, S.A.E./Metric
<b>TJZ039</b>	Ball Pein Hammer, 8 oz.	<b>TJZ079</b>	Groove Joint Pliers, 8" L	<b>TLZ420</b>	Chisel Set
<b>TJZ040</b>	Ball Pein Hammer, 16 oz.	<b>TJZ080</b>	Groove Joint Pliers, 10" L	<b>TLZ421</b>	Pin Punch Set
<b>TJZ041</b>	Ball Pein Hammer, 24 oz.	<b>TJZ082</b>	Diagonal Cutting Pliers, 5" L	<b>TLZ422</b>	Drift Punch Set
<b>TJZ042</b>	Ball Pein Hammer, 32 oz.	<b>TJZ083</b>	Diagonal Cutting Pliers, 6" L	<b>TLZ423</b>	Centre Punch Set
<b>TJZ043</b>	Rubber Mallet, Black, 16 oz.	<b>TJZ084</b>	Diagonal Cutting Pliers, 7" L	<b>TNB733</b>	Hex Key Set, S.A.E.
<b>TJZ044</b>	Rubber Mallet, Black, 32 oz.	<b>TJZ085</b>	Long Nose Cutting Pliers, 5" L	<b>TNB734</b>	Hex Key Set, Metric
<b>TJZ047</b>	Action Bar 13-1/2" L	<b>TJZ086</b>	Long Nose Cutting Pliers, 6" L	<b>TYB504</b>	C-clamp, 4" Jaw Width
<b>TJZ048</b>	Wrecking Bar, 18" L	<b>TJZ087</b>	Long Nose Cutting Pliers, 8" L	<b>TYB506</b>	C-clamp, 8" Jaw Width
<b>TJZ049</b>	wrecking Bar, 24" L	<b>TJZ088</b>	Linesman Pliers, 7" L	<b>TYB508</b>	C-clamp, 12" Jaw Width
<b>TJZ057</b>	1/8" Slot Screwdriver, 3" Shank	<b>TJZ089</b>	Linesman Pliers, 8" L	<b>XC488</b>	Extension Cord 25' L
<b>TJZ058</b>	3/16" Slot Screwdriver, 4" Shank	<b>TJZ090</b>	Locking Pliers, 4" L	<b>XE887</b>	LED Headlamp
<b>TJZ059</b>	3/16" Slot Screwdriver, 6" Shank	<b>TJZ091</b>	Locking Pliers, 5" L	<b>XE889</b>	LED Flashlight
<b>TJZ060</b>	1/4" Slot Stubby Screwdriver, 1-1/2" Shank	<b>TJZ092</b>	Locking Pliers, 7" L		
<b>TJZ061</b>	1/4" Slot Screwdriver, 4" Shank	<b>TJZ093</b>	Locking Pliers, 10" L		



# HAND TOOLS

Insulated Tools .....	17
Screwdrivers .....	17-19
Pliers .....	20-24
Wrenches .....	25-26
Hammers .....	27-30
Hex keys .....	31
Measuring Tools .....	31-32
Bars, Hacksaw & Bolt Cutters .....	33
Punches & Chisels .....	34-36

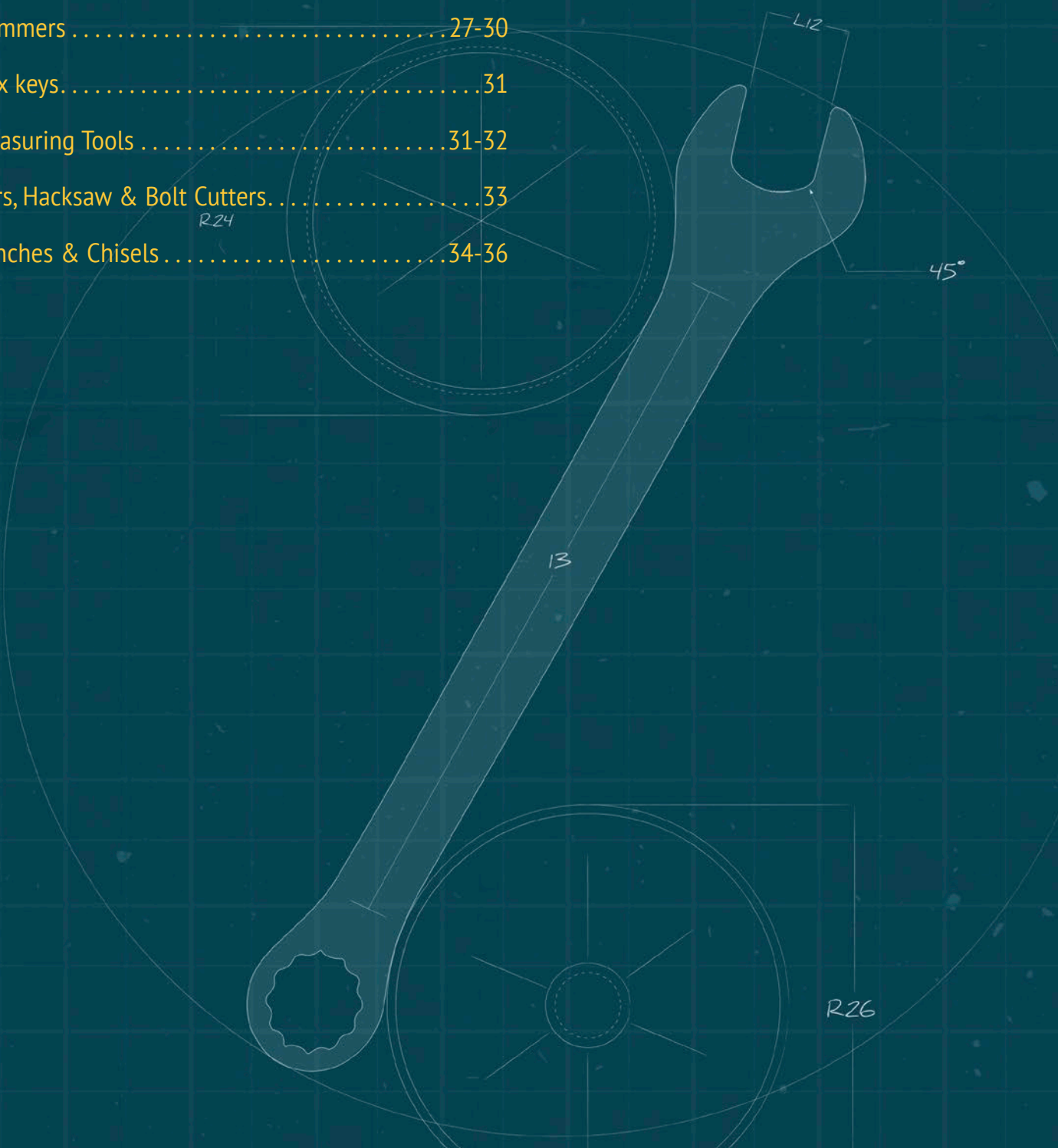

## INSULATED TOOL SET

- Meets the VDE insulated quality standard
- Leather carry case conveniently stores and protects tools
- Voltage Rating: 1000 V
- No. of Pieces: 10

### SET INCLUDES:

- VDE Slotted Screwdriver, 7/32" x 5" L
- VDE Slotted Screwdriver, 5/32" x 4" L
- VDE Slotted Screwdriver, 3/32" x 3" L
- VDE Phillips® Screwdriver, #1 x 3-1/8" L
- VDE Phillips® Screwdriver, #2 x 4" L
- VDE Pozidriv® Screwdriver, #1 x 3-1/8" L
- VDE Pozidriv® Screwdriver, #2 x 4" L
- VDE Lineman Pliers, 6" L
- VDE Long Nose Pliers, 6" L
- VDE Side Cutting Pliers, 6" L

Model No. TYP305



## ELECTRICAL TAPE

- Width: 3/4" (19 mm)
- Length: 60' (18 m)
- Material: Vinyl Plastic
- Colour: Black
- Thickness: 7 mils
- Electrical tape for splicing and insulating wires
- For use between -7°C and 80°C
- CSA approved

Model No. XE890





Screwdriver type indication on the base of the grip

- Industrial quality and strength
- Chrome vanadium steel blade
- Treated blade tip for a lifetime of performance
- Extra large ergonomic handle for maximum torque and comfort
- Colour-coded handle for square tip type
- Meets ANSI standards



Model No.	Tip Width"	Shank Length"
<b>● SLOT ELECTRICIANS</b>		
TJZ057	1/8	3
TJZ058	3/16	4
TJZ059	3/16	6
<b>● SLOT MECHANICS</b>		
TJZ060	1/4	1-1/2 Stubby
TJZ061	1/4	4
TJZ062	1/4	5
TJZ063	1/4	6
TJZ064	5/16	6
TJZ065	3/8	8
<b>◆ PHILLIPS TIP</b>		
TJZ066	#0	2-1/2
TJZ067	#1	3-1/4
TJZ068	#2	4
TJZ070	#3	6
TJZ069	#2	1-1/2 Stubby
<b>□ SQUARE TIP</b>		
TJZ071	#0	4
TJZ072	#1	4
TJZ073	#2	6
TJZ074	#3	6
TJZ075	#1	1-1/2 Stubby
TJZ076	#2	1-1/2 Stubby
TJZ077	#3	1-1/2 Stubby



Slot Electrician



Slot Mechanics



Phillips Tip



Square Tip





- Industrial quality and strength
- Treated blade tip for a lifetime of performance
- Meets ANSI standards



TJZ827

TJZ826

TJZ828

Model No.	Description	Contents
TJZ826	3-Piece Set	Square Tip: #1, #2, #3
TJZ827	7-Piece Set	Square Tip: #1, #2 Phillips: #1, #2 Flat: 1/8", 1/4", 5/16"
TJZ828	16-Piece Set	Square Tip: #0, #1, #2, #3, #2 Stubby Phillips: #0, #1, #2, #3, #2 Stubby Flat: 1/8", 3/16", 1/4", 5/16", 3/8", 1/4" Stubby



## SLIP JOINT PLIERS

- Sure gripping precision milled jaws
- Light and rugged drop-forged alloy steel
- Flush pivot design for use in tight spaces
- Meets ANSI standards

Model No.	Length"
TJZ078	6



## GROOVE JOINT PLIERS

- Sure gripping precision milled jaws
- Grooves undercut and milled to prevent slipping when tightening
- Light and rugged drop-forged alloy steel
- Flush pivot design for use in tight spaces
- Meets ANSI standards

Model No.	Length"
TJZ079	8
TJZ080	10



## DIAGONAL CUTTING PLIERS

- Precision tested jaws provide uniform cut
- Slim profile reaches into cramped quarters
- Black nickel finish resists rust
- Induction heat-treated cutting edge
- Smooth non-sticking lever mechanism
- Meets ANSI standards

Model No.	Length"
TJZ082	5
TJZ083	6
TJZ084	7



## LONG NOSE CUTTING PLIERS

- Strong sure gripping jaws manipulate wire and other awkward objects
- Slim tapered head extends reach and maintains visibility in small areas
- Black nickel finish resists rust
- Meets ANSI standards

Model No.	Length"
TJZ085	5
TJZ086	6
TJZ087	8



## LINESMAN CUTTING PLIERS

- Precision milled jaw grip and hold wire without slipping
- Black nickel finish resists rust
- Meets ANSI standards

Model No.	Length"
TJZ088	7
TJZ089	8



## INDUSTRIAL MULTI-TOOL

- Stainless steel components
- Anodized aluminum body with ABS inlays provides premium comfort
- Heavy-duty nylon pouch
- Self locking components for safe use
- Gun metal finish
- Overall length: 6.25"
- Closed length: 4"
- Weight: 9.3 oz.

**INCLUDES:** Flat-nose pliers, wire cutter, fine edge knife, Phillips screwdriver, bottle opener, small and medium flat screwdriver, metal/wood file, double tooth saw, serrated knife, can opener

**Model No. TLZ463**





## 3-PIECE BASIC PLIER SET

- Precision milled jaws
- Black nickel finish resists rust
- Meets ANSI standards

### SET INCLUDES:

- TJZ078** Slip Joint, 6" L
- TJZ083** Diagonal Cutting, 6" L
- TJZ086** Long Nose Cutting, 6" L

Model No. TLZ795



## 3-PIECE LONG NOSE CUTTING PLIER SET

- Strong sure gripping jaws manipulate wire and other awkward objects
- Slim tapered head extends reach and maintains visibility in small areas
- Black nickel finish resists rust
- Meets ANSI standards

### SET INCLUDES:

- TJZ085** Long Nose Cutting, 5" L
- TJZ086** Long Nose Cutting, 6" L
- TJZ087** Long Nose Cutting, 8" L

Model No. TLZ790

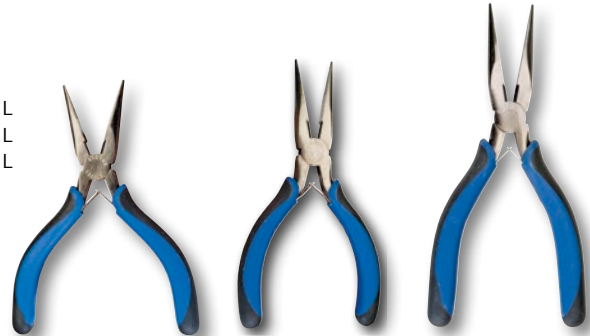

## 3-PIECE DIAGONAL CUTTING PLIER SET

- Precision tested jaws provide uniform cut
- Slim profile reaches into cramped quarters
- Black nickel finish resists rust
- Induction heat-treated cutting edge
- Smooth non-sticking lever mechanism
- Meets ANSI standards

### SET INCLUDES:

- TJZ082** Diagonal Cutting, 5" L
- TJZ083** Diagonal Cutting, 6" L
- TJZ084** Diagonal Cutting, 7" L

Model No. TLZ789



## 11-PIECE ALL-PURPOSE PLIER SET

- Precision milled jaws wire without slipping
- Black nickel finish resists rust
- Meets ANSI standards

### SET INCLUDES:

- TJZ078** Slip Joint, 6" L
- TJZ079** Groove Joint, 8" L
- TJZ080** Groove Joint, 10" L
- TJZ082** Diagonal Cutting, 5" L
- TJZ083** Diagonal Cutting, 6" L
- TJZ084** Diagonal Cutting, 7" L
- TJZ085** Long Nose Cutting, 5" L
- TJZ086** Long Nose Cutting, 6" L
- TJZ087** Long Nose Cutting, 8" L
- TJZ088** Linesman Cutting, 7" L
- TJZ089** Linesman Cutting, 8" L

Model No. TLZ793





## CURVED JAW PLIERS WITH WIRE CUTTING

Model No.	Grip	Length"
TJZ090	Steel	4
TJZ091	Composite	5
TJZ092	Composite	7
TJZ093	Composite	10



- Tempered chrome vanadium steel jaws
- Hardened tension bar with toggle mechanism provides secure locking action
- Smooth screw adjustment for easy and rapid setting
- Meets ANSI standards



## LONG NOSE PLIERS WITH WIRE CUTTING

Model No.	Grip	Length"
TJZ094	Steel	4
TJZ095	Composite	6



## C-CLAMP PLIERS WITH SWIVEL PADS

Model No.	Grip	Length"
TJZ096	Steel	6
TJZ097	Steel	11



## LOCKING WELDING CLAMP PLIERS

Model No.	Grip	Length"
TJZ098	Steel	9



## LOCKING SHEET METAL TOOL PLIERS

Model No.	Grip	Length"
TJZ099	Steel	8

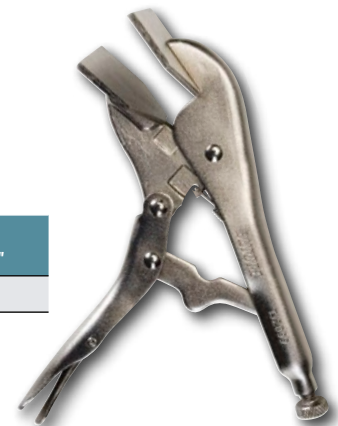

## 4-PIECE CURVED JAW LOCKING PLIERS W/WIRE CUTTER SET

- Tempered chrome vanadium steel jaws
- Hardened tension bar with toggle mechanism provides secure locking action
- Smooth screw adjustment for easy and rapid setting
- Meets ANSI standards



### SET INCLUDES:

- TJZ090** Curved Jaw w/ Wire Cutter, 4" L
- TJZ091** Curved Jaw w/ Wire Cutter, 5" L
- TJZ092** Curved Jaw w/ Wire Cutter, 7" L
- TJZ093** Curved Jaw w/ Wire Cutter, 10" L

Model No. TLZ791



## 8-PIECE LOCKING PLIER SET

- Tempered chrome vanadium steel jaws
- Hardened tension bar with toggle mechanism provides secure locking action
- Smooth screw adjustment for easy and rapid setting
- Meets ANSI standards

### SET INCLUDES:

- TJZ090** Curved Jaw w/ Wire Cutter, 4" L
- TJZ091** Curved Jaw w/ Wire Cutter, 5" L
- TJZ092** Curved Jaw w/ Wire Cutter, 7" L
- TJZ093** Curved Jaw w/ Wire Cutter, 10" L
- TJZ094** Long Nose w/ Wire Cutter, 4" L
- TJZ095** Long Nose w/ Wire Cutter, 6" L
- TJZ096** C-clamps w/ Swivel Pads, 6" L
- TJZ097** C-clamps w/ Swivel Pads, 11" L

Model No. TLZ792



## 4-PIECE WELDING CLAMP SET

### SET INCLUDES:

- TJZ096** C-Clamp with Swivel Pad, 6"
- TJZ997** C-Clamp with Swivel Pad, 11"
- TJZ998** Locking Welding Clamp, 9"
- TJZ099** Locking Sheet Metal Tool, 8"

Model No. TLV133



## 19-PIECE ALL PURPOSE PLIER SET

### PLIERS:

- Precision milled jaws
- Black nickel finish resists rust
- Meets ANSI standards

### LOCKING PLIERS:

- Tempered chrome vanadium steel jaws
- Hardened tension bar with toggle mechanism provides secure locking action
- Smooth screw adjustment for easy and rapid setting
- Meets ANSI standards

### SET INCLUDES:

#### PLIERS, BLACK NICKEL FINISH:

- TJZ078** Slip Joint, 6" L
- TJZ079** Groove Joint, 8" L
- TJZ080** Groove Joint, 10" L
- TJZ082** Diagonal Cutting, 5" L
- TJZ083** Diagonal Cutting, 6" L
- TJZ084** Diagonal Cutting, 7" L
- TJZ085** Long Nose Cutting, 5" L
- TJZ086** Long Nose Cutting, 6" L
- TJZ087** Long Nose Cutting, 8" L

#### LOCKING PLIERS:

- TJZ088** Linesman Cutting, 7" L
- TJZ089** Linesman Cutting, 8" L
- TJZ090** Curved Jaw w/ Wire Cutter, 4" L
- TJZ091** Curved Jaw w/ Wire Cutter, 5" L
- TJZ092** Curved Jaw w/ Wire Cutter, 7" L
- TJZ093** Curved Jaw w/ Wire Cutter, 10" L
- TJZ094** Long Nose w/ Wire Cutter, 4" L
- TJZ095** Long Nose w/ Wire Cutter, 6" L
- TJZ096** C-clamps w/ Swivel Pads, 6" L
- TJZ097** C-clamps w/ Swivel Pads, 11" L

Model No. TLZ794







## COMBINATION WRENCHES

- Chrome vanadium steel for strength and durability
- Heat treated for consistent hardness
- Precision broached jaws for sure gripping
- 12-point box end for snug fit
- Thin walled construction for access in cramped quarters
- Meets ANSI standards

Model No.	Size"	Length"
<b>S.A.E.</b>		
TYK599	1/4	3-7/8
TYK600	5/16	4-3/4
TYK601	11/32	5-1/8
TYK602	3/8	6
TYK603	7/16	6
TYK604	1/2	6-3/4
TYK605	9/16	7-1/8
TYK606	5/8	8
TYK607	11/16	8-11/16
TYK608	3/4	9
TYK609	13/16	9-5/8
TYK610	7/8	10-1/4
TYK611	15/16	10-1/2
TYK612	1	11-5/8
TYK613	1 1/16	13-3/8
TYK614	1 1/8	15
TYK615	1 1/4	17-1/8

Model No.	Size mm	Length mm
<b>METRIC</b>		
TYK616	6	100
TYK617	7	110
TYK618	8	131
TYK619	9	130
TYK620	10	151
TYK621	11	150
TYK622	12	161
TYK623	13	171
TYK624	14	181
TYK625	15	191
TYK626	16	195
TYK627	17	211
TYK628	18	215
TYK629	19	231
TYK630	20	235
TYK631	21	245
TYK632	22	250
TYK633	23	265
TYK634	24	292
TYK635	25	285
TYK636	26	295
TYK637	27	340
TYK638	28	355
TYK639	29	380
TYK640	30	395
TYK641	32	373

## COMBINATION WRENCH SETS



Model No.	Description
TLV053	<b>11 S.A.E. Combination Wrenches:</b> 1/4", 5/16", 3/8", 7/16", 1/2", 9/16", 5/8", 11/16", 3/4", 13/16", 7/8"
TLV054	<b>11 Metric Combination Wrenches:</b> 7 mm, 8 mm, 9 mm, 10 mm, 11 mm, 12 mm, 13 mm, 14 mm, 15 mm, 17 mm, 19 mm
TLV055	<b>14 S.A.E. Combination Wrenches:</b> 3/8", 7/16", 1/2", 9/16", 5/8", 11/16", 3/4", 13/16", 7/8", 15/16", 1", 1-1/16", 1-1/8", 1-1/4"
TLV056	<b>14 Metric Combination Wrenches:</b> 10 mm, 12 mm, 13 mm, 14 mm, 15 mm, 16 mm, 17 mm, 18 mm, 19 mm, 22 mm, 24 mm, 27 mm, 30 mm, 32 mm

## ADJUSTABLE WRENCHES

- Superior grade chrome vanadium steel
- Precision machined jaws
- Slim profile head slips into cramped quarters
- Tight tolerances ensure close fitting, wobble-free action
- Smooth, non-sticking mechanism
- Black nickel finish resists rust
- Meets ANSI standards



Model No.	Length"	Description
TJZ100	6	Standard Jaw, Composite Body
TJZ101	8	Reversible Jaw, Composite Body
TJZ102	10	Reversible Jaw, Composite Body
TJZ103	12	Reversible Jaw, Composite Body
TJZ104	15	Standard Jaw, Steel Body
TJZ105	18	Standard Jaw, Steel Body

## 6-PIECE ADJUSTABLE WRENCH SET

**SET INCLUDES:** TJZ100, TJZ101, TJZ102, TJZ103, TJZ104 & TJZ105

**Model No. TLZ796**



## PIPE WRENCHES

- Drop-forged alloy steel jaw
- Durable ductile steel body provides the ultimate in performance
- Precision milled sure gripping teeth
- Spring action ensures sure grip and quick release

Model No.	Length"	Pipe Capacity"
TJZ106	8	1
TJZ107	10	1-1/2
TJZ108	12	2
TJZ109	14	2
TJZ110	18	2-1/2



TJZ106

# INDESTRUCTIBLE HANDLE HAMMERS

## INDESTRUCTIBLE HANDLE HAMMERS

- Indestructible handle is made with spring steel bars, encased in rubber, running through the hammer head
- Spring steel bars are locked into the hammer head with steel locking plates, ensuring it never dislodges
- Ergonomic rubber grip handle absorbs impact and vibration reducing user fatigue
- Will not break, bend, or split even after repeated overstrikes
- Head is induction case hardened 52-56 HRC
- Meets ANSI BS 876 standard for material hardness and performance



Model No.	Head Weight lbs.	No. of Spring Steel Bars	Handle Length"
<b>SLEDGE HAMMERS</b>			
TYB494	6	6	24
TYB495	8	6	24
TYB496	8	6	30
TYB497	10	6	30
TYB498	12	6	30
TYB499	14	6	30
<b>CLUB HAMMERS</b>			
TYB492	4	4	12
TYB493	4	4	16



# HAMMERS & MALLETS

## TUBULAR HANDLE HAMMER

- 1.4 mm hardened tubular steel shaft
- Fully polished heat-treated face with octagonal neck
- Shock-absorbing cushion grip handle
- Steel overstrike ring
- Meets ANSI standards

Model No.	Type	Head Weight oz.
TJZ032	Claw	16



## HICKORY HANDLE HAMMERS

- Large natural colour, American hickory handle
- Extra tough, heat-treated fully polished head
- Extra large striking face
- Natural shock absorbing qualities of natural wood
- Meets ANSI standards

Model No.	Type	Head Weight oz.
TJZ033	Claw	16
TJZ034	Framing	22



## DEAD BLOW HAMMERS

- 1-piece urethane construction
- Completely enclosed steel shank
- Shot-filled head
- High visibility orange colour

Model No.	Head Weight oz.
TJZ035	8
TJZ036	16
TJZ037	24
TJZ038	32



## BALL PEIN HAMMERS

- Kiln-dried hickory handle
- High quality construction
- Natural shock-absorbing qualities of natural wood
- Meets ANSI standards

Model No.	Head Weight oz.
TJZ039	8
TJZ040	16
TJZ041	24
TJZ042	32



## RUBBER MALLETS

- Hardwood handle
- Non-marking white rubber head (TJZ045 and TJZ046)

Model No.	Head Weight oz.	Colour
TJZ043	16	Black
TJZ044	32	Black
TJZ045	16	White
TJZ046	32	White





## 2-PIECE HICKORY HANDLE HAMMER SET

- Large natural colour, American hickory handle
- Extra tough, heat-treated fully polished head
- Extra large striking face
- Natural shock absorbing qualities of natural wood
- Meets ANSI standards

### SET INCLUDES

- TJZ033** Hickory Handle, Claw Hammer, 16 oz.  
**TJZ034** Hickory Handle, Claw Hammer, 22 oz.

Model No. TLV114



## 4-PIECE DEAD BLOW HAMMER SET

- One piece urethane construction
- Completely enclosed steel shank
- Shot-filled head
- High visibility orange colour

### SET INCLUDES:

- TJZ035** Dead Blow Hammer, 8 oz.  
**TJZ036** Dead Blow Hammer, 16 oz.  
**TJZ037** Dead Blow Hammer, 24 oz.  
**TJZ038** Dead Blow Hammer, 32 oz.

Model No. TLV113



## 4-PIECE BALL PEIN HAMMER SET

- Kiln-dried hickory handle
- High quality construction
- Natural shock-absorbing qualities of natural wood
- Meets ANSI standards

### SET INCLUDES:

- TJZ039** Ball Pein Hammer 8 oz.  
**TJZ040** Ball Pein Hammer, 16 oz.  
**TJZ041** Ball Pein Hammer, 24 oz.  
**TJZ042** Ball Pein Hammer, 32 oz.

Model No. TLV112



## 4-PIECE RUBBER MALLET SET

- Hardwood handle
- Non-marking white rubber head (**TJZ045** and **TJZ046**)

### SET INCLUDES:

- TJZ043** Mallet, Black, 16 oz.  
**TJZ044** Mallet, Black, 32 oz.  
**TJZ045** Mallet, White, 16 oz.  
**TJZ046** Mallet, White, 32 oz.

Model No. TLV115

# HAMMER SETS & STAMP SETS

HAND TOOLS

## 8-PIECE UNIVERSAL HAMMER SET

- The most popular striking tools for a wide variety of applications

### SET INCLUDES:

- TJZ032 Claw Hammer, Tubular Handle, 16 oz.
- TJZ034 Framing Hammer, Hickory Handle, 22 oz.
- TJZ036 Dead Blow Hammer, 16 oz.
- TJZ038 Dead Blow Hammer, 32 oz.
- TJZ040 Ball Pein Hammer, 16 oz.
- TJZ042 Ball Pein Hammer, 32 oz.
- TJZ044 Mallet, Black, 32 oz.
- TJZ045 Mallet, White, 16 oz.

Model No. TLV116



## 15-PIECE ULTIMATE HAMMER SET

- The most comprehensive hammer set on the market
- Includes a hammer for virtually every application

### SET INCLUDES:

- TJZ032 Claw Hammer, Tubular Handle, 16 oz.
- TJZ033 Claw Hammer, Hickory Handle, 16 oz.
- TJZ034 Framing Hammer, Hickory Handle, 22 oz.
- TJZ035 Dead Blow Hammer, 8 oz.
- TJZ036 Dead Blow Hammer, 16 oz.
- TJZ037 Dead Blow Hammer, 24 oz.
- TJZ038 Dead Blow Hammer, 32 oz.
- TJZ039 Ball Pein Hammer, 8 oz.
- TJZ040 Ball Pein Hammer, 16 oz.
- TJZ041 Ball Pein Hammer, 24 oz.
- TJZ042 Ball Pein Hammer, 32 oz.
- TJZ043 Mallet, Black, 16 oz.
- TJZ044 Mallet, Black, 32 oz.
- TJZ045 Mallet, White, 16 oz.
- TJZ046 Mallet, White, 32 oz.

Model No. TLV117



## STAMP SETS

- For hand held, hammer struck applications
- Manufactured from high quality steel
- Induction hardened for added durability and extended life
- Beveled striking edge prevents breakage and accidents during use
- Stamping end is hardened at 58-62 HRC and the striking end is hardened to 38-43 HRC to prevent splintering
- Letter sets contain 27 pieces, "A" through "Z" and "&"- (ampersand)
- Number sets contain 9 pieces, "0" through "9", numbers "6" and "9" are interchangeable

Model No.	Stamp Size"	Type
TLZ389	1/8	Number
TLZ392	1/8	Letter
TLZ390	3/16	Number
TLZ393	3/16	Letter
TLZ391	1/4	Number
TLZ394	1/4	Letter





## HEX KEY POUCH SETS

- Chrome vanadium steel for strength and durability
- Tips are chamfered for ease of entry and proper fit

Model No.	No. of Keys	Key Sizes
<b>S.A.E. - SHORT ARM</b>		
TNB731	13	1/20", 1/16", 5/64", 3/32", 7/64", 1/8", 9/64", 5/32", 3/16", 7/32", 1/4", 5/16", 3/8"
<b>METRIC - SHORT ARM</b>		
TNB732	9	1.5 mm, 2.0 mm, 2.5 mm, 3.0 mm, 4.0 mm, 5.0 mm, 6.0 mm, 8.0 mm, 10.0 mm



TNB731

TNB732

## FOLDING HEX KEY SETS

- Chrome vanadium steel for strength and durability
- Tips are chamfered for ease of entry and proper fit
- Set folds securely into convenient storage compartment

Model No.	No. of Keys	Key Sizes
<b>S.A.E. FOLD UP</b>		
TNB733	9	5/64", 3/32", 7/64", 1/8", 9/64", 5/32", 3/16", 7/32", 1/4"
<b>METRIC FOLD UP</b>		
TNB734	8	1.5 mm, 2.0 mm, 2.5 mm, 3.0 mm, 4.0 mm, 5.0 mm, 6.0 mm, 8.0 mm
<b>S.A.E. - BALL END FOLD UP</b>		
TNB735	9	5/64", 3/32", 7/64", 1/8", 9/64", 5/32", 3/16", 7/32", 1/4"

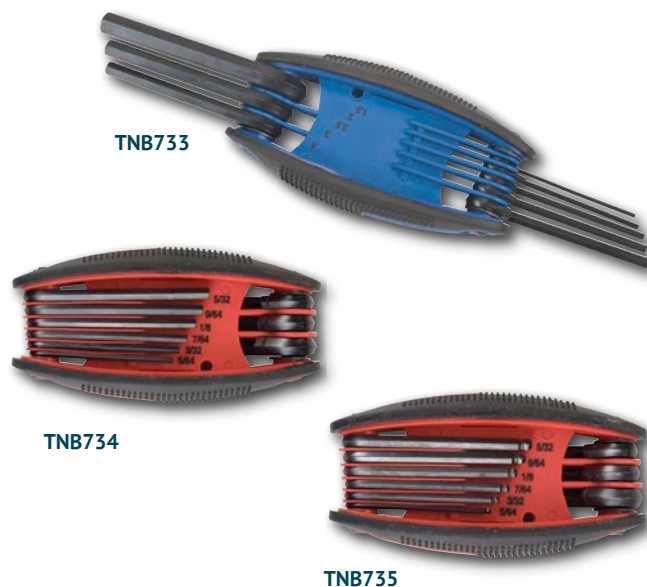

TNB733

TNB734

TNB735

## MEASURING TAPES

- Heavy-duty tape line
- Sure locking break
- Easy-to-read blade
- Two rivets holding the tip for extra security
- Composite covering for extra comfort

Model No.	Blade Width"	Length'	Graduation
TJZ115	5/8	12	in/ft
TJZ116	5/8	12	in/cm
TJZ117	3/4	16	in/ft
TJZ118	3/4	16	in/cm
TJZ801	1	25	in/ft
TJZ802	1	25	in/cm
TJZ803	1	30	in/ft
TJZ804	1-1/4	25	in/ft



## ELECTRONIC DIGITAL CALIPERS

- Large LCD display provides easy-to-read numbers
- Hardened stainless steel head and body
- Precision adjustments for accurate measurements
- Lock screw to hold slide in position
- Inch/millimeter conversion
- Zero at any position
- Linear accuracy:  $\pm 0.001"$  (0.03 mm)
- Deluxe storage case with foam insert
- Includes two 1.5 V batteries

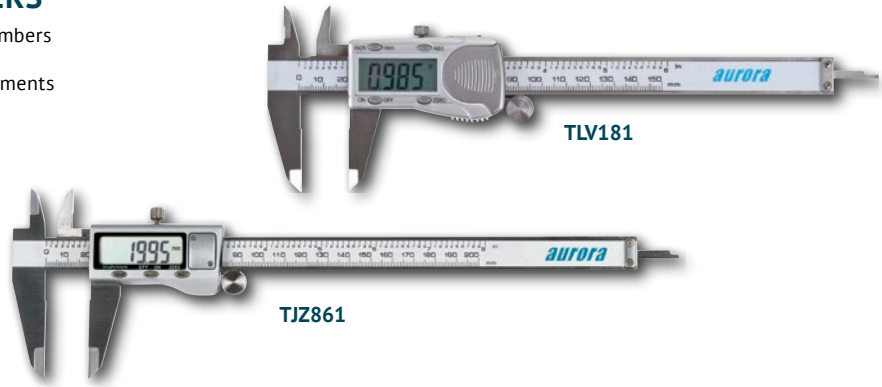

Model No.	Length"	Description	Measurement Range	Jaw Depth Outside - Inside
TLV181	6	Stainless Steel Body, Plastic Head	0 - 6" (0-152 mm)	1-9/16" - 13/16" (40-21 mm)
TGZ370	6	Stainless Steel Body, Zinc Alloy Head	0 - 6" (0-152 mm)	1-9/16" - 13/16" (40-21 mm)
TJZ861	8	Stainless Steel Body, Zinc Alloy Head	0 - 8" (0-200 mm)	1-13/16" - 1" (46-26 mm)
THZ769	12	Stainless Steel Body, Zinc Alloy Head	0 - 12" (0-305 mm)	2-3/8" - 1" (60-26 mm)

## ELECTRONIC DIGITAL MICROMETER

- Large LCD display provides easy-to-read numbers
- Carbide tipped measurement surfaces
- Resolution to 5 decimal places
- Linear accuracy:  $\pm 0.0001"$  (0.03 mm)
- Inch/millimeter conversion
- Thimble ratchet
- Zero at any position
- Lock screw to hold mechanism in position
- Automatic OFF button
- Includes: Calibration wrench, two 1.5 V batteries, type LR44, wooden storage case with foam insert



Model No.	Measurement Range	Resolution
IA388	0-1" (0-25 mm)	0.00005" (0.001 mm)

## MEASURING WHEEL

- Resolution: 0.1 m
- Power: 3V (2x LR3 Batteries)
- Suitable Temperature:  $-10^{\circ}\text{C}$  to  $+45^{\circ}\text{C}$
- Lightweight and easy to use, designed for professional and personal usage
- Large wheel model ensures accuracy and is ideal for uneven terrain
- Suitable for outdoor and indoor distance measuring applications
- Pistol grip handle for ergonomic comfort
- Backlight for low light conditions
- Metric and imperial measurement with 5 memory storage entries
- Accuracy of  $\pm 0.5\%$
- Telescopic handle
- Push button reset
- Adds forward, subtracts in reverse
- Equipped with a sturdy flip-down kickstand and carrying bag for easy storage and portability
- Measuring Range: 99999.9 m
- Graduations: Feet/Metres
- Wheel Diameter: 12.5" (31.8 cm)

Model No. TYY302



## HACKSAW

- Heavy 16-gauge round steel tubing
- Comfort and guarded grip handle
- Blade Length: 12"
- Depth of Bow: 4"
- Tensile Strength: 8000 PSI

Model No. TYW991



## ACTION BAR

- High quality heat-treated carbon steel
- Edges are specially bevelled for pulling, lifting and scraping
- Baked paint finish
- 13-1/2" L x 1-3/8" W
- Colour: Black

Model No. TJZ047



## WRECKING BAR

- High quality steel
- Width: 7/8"
- Overall Length: 14"
- Colour: Black

Model No. TYL028



## BOLT CUTTERS

- Chrome molybdenum steel jaws
- Centre cutting blades
- Adjusting screws allow for easy and perfect alignment of jaws
- Strong tubular handle with slip-proof rubber grips

Model No.	Length"	Max. Jaw Opening"
TJZ111	14	1/4
TJZ112	18	5/16
TJZ113	24	3/8
TJZ114	36	9/16



## GOOSENECK WRECKING BARS

- High quality steel
- Hexagon shank
- Bevelled edges for pulling and lifting

Model No.	Diameter"	Length"	Weight lbs.
TJZ048	5/8	18	2
TJZ049	3/4	24	3.5
TJZ050	3/4	30	4.4
TJZ051	3/4	36	5





## COLD CHISELS

- Individually forged from high quality alloy steel
- Manufactured to the highest safety standards
- Precisely ground cutting edge is induction hardened to 52-58 HRC
- Striking head is hardened to 42 HRC to prevent splintering during use



Cold Chisels



Model No.	Cut Width"	Stock Size"	Overall Length"
TLZ395	1/4	1/4	5
TLZ396	5/16	1/4	5
TLZ397	3/8	5/16	5-1/2
TLZ398	1/2	7/16	6
TLZ399	5/8	1/2	6-1/2
TLZ400	3/4	5/8	7
TLZ556	7/8	3/4	7-1/2

## 6-PC. COLD CHISEL SETS

Model No. TLZ420

SET INCLUDES SIZES:

1/4", 5/16", 3/8", 1/2", 5/8", & 3/4"



## PIN PUNCHES

- Ideal for driving out and removing already loosened pins and keys after initial movement by a starting punch
- Manufactured from high quality carbon steel
- Single piece construction with hexagonal shank increases durability
- Accurately hardened for increased service life



Pin Punches



Model No.	Point Diameter"	Stock Size"	Overall Length"
TLZ401	1/16	1/4	4
TLZ402	3/32	5/16	4-1/2
TLZ403	1/8	5/16	4-3/4
TLZ404	5/32	5/16	5
TLZ405	3/16	5/16	5-1/4
TLZ555	7/32	3/8	5-1/2
TLZ406	1/4	3/8	5-3/4
TLZ407	5/16	7/16	6

## 7-PC. PIN PUNCH SETS

Model No. TLZ421

SET INCLUDES SIZES:

1/16", 3/32", 1/8", 5/32", 3/16", 7/32", & 1/4"



Model No.	Point Diameter"	Stock Size"	Overall Length"
TLZ408	1/8	5/16	8
TLZ409	5/32	3/8	9
TLZ410	3/16	1/2	10
TLZ411	7/32	1/2	10
TLZ412	1/4	5/8	12
TLZ413	5/16	3/4	12
TLZ414	3/8	3/4	15

## DRIFT PUNCHES

- Ideal for lining up holes in two or more pieces of metal and for drawing pins through various assemblies
- Manufactured from high quality carbon steel
- Single piece construction with hexagonal shank increases durability
- Accurately hardened for increased service life



Drift Punches



## 7-PC. DRIFT PUNCH SETS

Model No. TLZ422

**SET INCLUDES SIZES:**

1/8", 5/32", 3/16", 7/32", 1/4", 5/16", & 3/8"

Model No.	Point Diameter"	Stock Size"	Overall Length"
TLZ415	5/64	1/4	3-1/2
TLZ416	1/8	5/16	4-1/4
TLZ417	5/32	3/8	5
TLZ418	1/4	1/2	6
TLZ419	3/8	5/8	6-1/4

## CENTER PUNCH

- Single piece construction with hexagonal shank increases durability
- Manufactured from high quality carbon steel
- Accurately hardened for increased service life
- Beveled striking end to prevent breakage
- Working tips centered and ground to 90° for increased marking efficiency

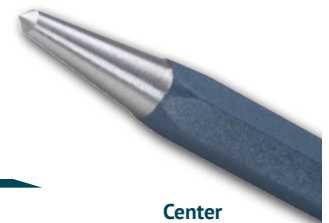

Center Punches



## 5-PC. CENTER PUNCH SETS

Model No. TLZ423

**SET INCLUDES SIZES:**

5/64", 1/8", 5/32", 1/4", & 3/8"



Cold Chisels With Grip Guard



## COLD CHISELS WITH GRIP GUARD

- Individually forged from high quality alloy steel
- Manufactured to the highest safety standards
- Precisely ground cutting edge is induction hardened to 52-58 HRC
- Striking head is hardened to 42 HRC to prevent splintering during use

Model No.	Cut Width"	Stock Size"	Overall Length"
TYB509	3/4	5/8	10
TYB510	3/4	5/8	12
TYB511	1	7/8	10
TYB512	1	7/8	12

## PUNCH & CHISEL SETS

- Punch and chisel sets are an excellent way to keep your tools organized. These sets are packed in heavy-duty vinyl rolls for easy access, organization and storage.



### 8-PC. PUNCH AND CHISEL SET:

Model No. TLZ433

#### SET INCLUDES:

Model No.	Style	Size"
TLZ398	Cold Chisel	1/2
TLZ399	Cold Chisel	5/8
TLZ400	Cold Chisel	3/4
TLZ417	Center Punch	5/32
TLZ403	Pin Punch	1/8
TLZ405	Pin Punch	3/16
TLZ406	Pin Punch	1/4
TLZ410	Drift Punch	3/16



### 14-PC. PUNCH AND CHISEL SET:

Model No. TLZ434

#### SET INCLUDES:

Model No.	Style	Size"
TLZ397	Cold Chisel	3/8
TLZ398	Cold Chisel	1/2
TLZ399	Cold Chisel	5/8
TLZ400	Cold Chisel	3/4
TLZ556	Cold Chisel	7/8
TLZ416	Center Punch	1/8
TLZ417	Center Punch	5/32
TLZ418	Center Punch	1/4
TLZ401	Pin Punch	1/16
TLZ403	Pin Punch	1/8
TLZ405	Pin Punch	3/16
TLZ408	Drift Punch	1/8
TLZ409	Drift Punch	5/32
TLZ413	Drift Punch	5/16



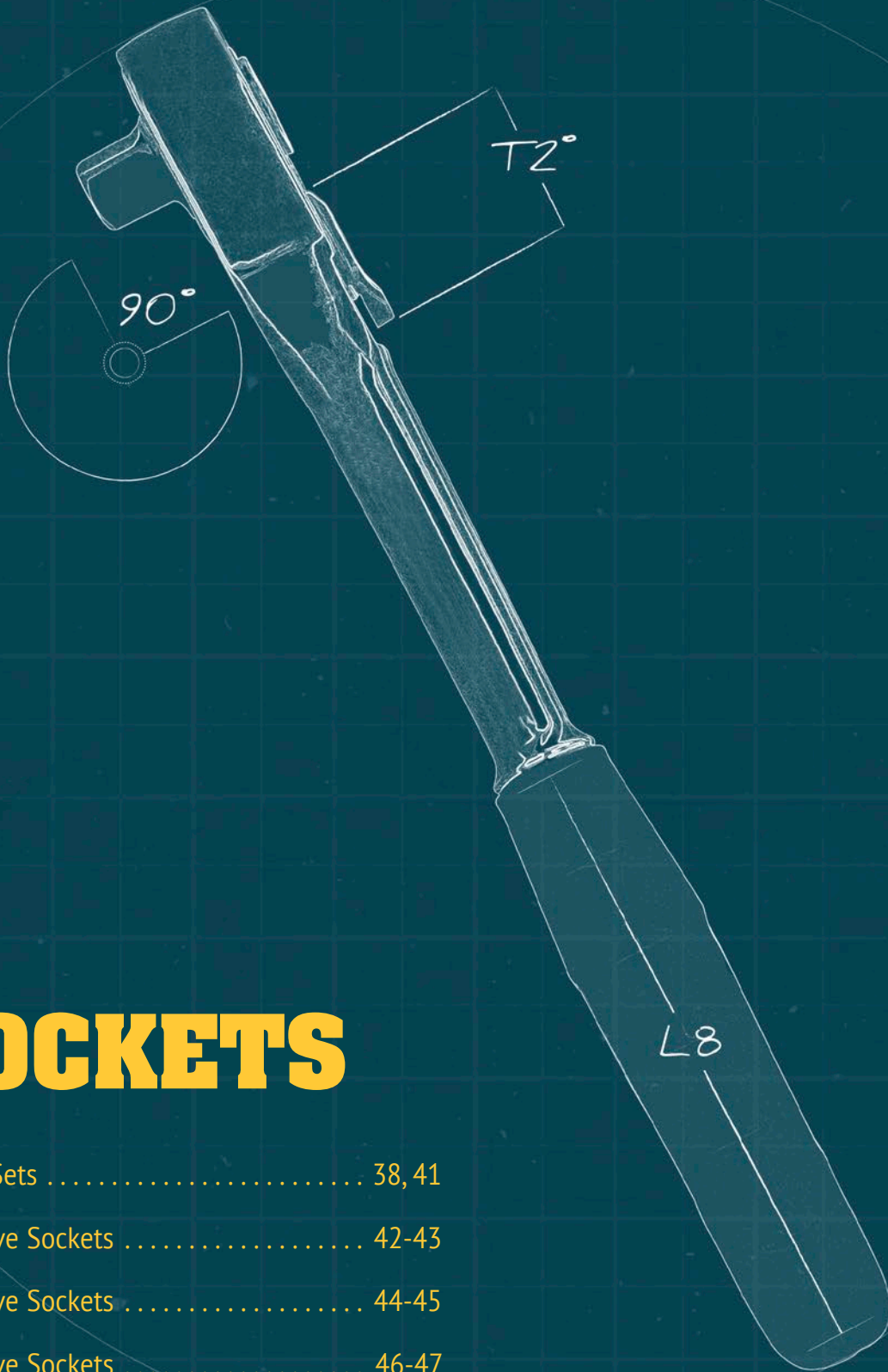

# SOCKETS

Socket Sets .....	38, 41
1/4" Drive Sockets .....	42-43
3/8" Drive Sockets .....	44-45
1/2" Drive Sockets .....	46-47

## 210-PIECE 1/4", 3/8" & 1/2" DRIVE S.A.E./METRIC SOCKET & WRENCH SET

- Chrome vanadium steel for extra strength and durability
- Ratchet with contoured handle for comfort and added torque
- Chrome-plated sockets to resist rust
- 6-point sockets for a snug fit
- Laser-marked socket size on each socket for easy identification
- Meets ANSI standards



### SET INCLUDES:

#### 24 Standard Sockets (1/4"):

5/32", 3/16", 7/32", 1/4", 9/32", 5/16",  
11/32", 3/8", 7/16", 1/2", 9/16"  
4, 4.5, 5, 6, 6.5, 7, 8, 9, 10, 11, 12, 13, 14 mm

#### 25 Standard Sockets (3/8"):

1/4", 9/32", 5/16", 11/32", 3/8",  
7/16", 1/2", 9/16", 5/8", 11/16", 3/4"  
6, 7, 8, 9, 10, 11, 12, 13, 14, 15, 16, 17, 18, 19 mm

#### 27 Standard Sockets (1/2"):

5/16", 3/8", 7/16", 1/2", 9/16", 5/8", 11/16", 3/4", 7/8", 1"  
8, 9, 10, 11, 12, 13, 14, 15, 16, 17, 18, 19, 20, 21, 22, 23, 24 mm

#### 15 Sae Sockets (1/4"):

1/4", 5/16", 3/8", 7/16", 1/2", 9/16"  
6, 7, 8, 9, 10, 11, 12, 13, 14 mm

#### 20 Sae Sockets (3/8"):

5/16", 3/8", 7/16", 1/2", 9/16", 5/8", 11/16", 3/4"  
8, 9, 10, 11, 12, 13, 14, 15, 16, 17, 18, 19 mm

#### 21 Deep Sockets (1/2"):

5/16", 3/8", 7/16", 1/2", 9/16", 5/8", 11/16", 3/4", 13/16", 7/8"  
10, 11, 12, 13, 14, 16, 17, 19, 20, 21, 22 mm

Model No. TLV362

#### 30 Shank Bits (1/4"):

Phillips: #0, #1, #2, #3  
Slotted 3, 4, 5, 6, 7, 8 mm  
Pozidriv: #0, #1, #2, #3  
Hex: 2, 3, 4, 5, 6, 8 mm  
Torx: T8, T10, T15, T20, T25, T27, T30  
Square: 1, 2, 3

#### 12 Shank Bits (8 mm):

Phillips: #3, #4  
Pozidriv: #3, #4  
Hex: 8, 10, 12, 14 mm  
Torx: T40, T45, T50, T55

#### 36 Accessories:

Quick Release Ratchet 1/4", 3/8", 1/2"  
Spark Plug Socket 1/2" Drive: 16, 21 mm  
Universal Joint 1/4", 3/8", 1/2"  
Extension 1/4" Drive: 2" & 4"  
Extensions 3/8" Drive: 3" & 6"  
Extensions 1/2" Drive: 5" & 10"  
Plastic Handle Driver 1/4" Drive  
Sliding T-bar: 1/4" & 3/8"  
3-way Adapter (3/8" F x 1/2" M)  
Bit Adapter 1/4" Drive  
Bit Adapter 1/2" Drive  
Combination Wrench:  
5/16", 3/8", 7/16", 1/2", 9/16", 5/8", 11/16", 3/4"  
8, 10, 11, 13, 14, 16, 18, 19 mm



## 120-PIECE 1/4", 3/8" & 1/2" DRIVE S.A.E./METRIC SOCKET SET

- Chrome vanadium steel for extra strength and durability
- Ratchet with contoured handle for comfort and added torque
- Chrome-plated sockets to resist rust
- 6-point sockets for a snug fit
- Laser-marked socket size on each socket for easy identification
- Meets ANSI standards

### SET INCLUDES:

#### 20 Standard Sockets (1/4"):

5/32", 3/16", 7/32", 1/4", 9/32", 5/16", 11/32", 3/8", 7/16", 1/2"  
4, 5, 6, 7, 8, 9, 10, 11, 12, 13 mm

#### 18 Standard Sockets (3/8"):

3/8", 7/16", 1/2", 9/16", 5/8", 11/16", 3/4"  
9, 10, 11, 12, 13, 14, 15, 16, 17, 18, 19 mm

#### 13 Standard Sockets (1/2"):

13/16", 7/8", 15/16", 1", 1-1/16", 1-1/4"  
20, 21, 22, 24, 27, 30, 32 mm

#### 4 Deep Sockets (1/4"):

8, 9, 10, 11 mm

#### 4 Deep Sockets (3/8"):

13, 14, 15, 17 mm

#### 8 Torx Sockets (3/8"):

E8, E10, E11, E12, E14, E16, E18, E20

#### 4 Impact Sockets (1/2"):

17, 19, 21, 24 mm

#### 7 Torx Bits (1/4"):

T10, T15, T20, T25, T27, T30, T40

#### 17 Bit Sockets (3/8"):

Torx: T20, T30 T40, T45, T50, T55, T60

Hex: 3, 4, 5, 6 mm

Phillips: #1, #2

Slotted: 5.5, 6.5 mm

Pozidriv: #1, #2

#### 23 Accessories:

Quick Release Ratchet: 1/4", 3/8", & 1/2"

Spark Plug Socket 3/8" Drive: 16, 21 mm

Universal Joint: 1/4", 3/8" & 1/2"

Extension 1/4" Drive: 2"

Extension 3/8" Drive: 3" & 6"

Extension 1/2" Drive: 5" & 10"

Plastic Handle Driver 1/4" Drive

Bit Adapter 1/4" Drive

Combination Wrench: 8, 9, 10, 11, 12, 13, 14, 17, 18, 19 mm



Model No. TLV361



## 41-PIECE 1/4" & 3/8" DRIVE S.A.E./METRIC SOCKET SET

- Chrome vanadium steel for extra strength and durability
- Ratchet with contoured handle for comfort and added torque
- Chrome-plated sockets to resist rust
- 6-point sockets for a snug fit
- Laser-marked socket size on each socket for easy identification
- Meets ANSI standards

### SET INCLUDES:

#### 19 Standard Sockets (1/4"):

3/16", 7/32", 1/4", 9/32", 5/16", 11/32", 3/8", 7/16", 1/2"  
4, 4.5, 5, 6, 7, 8, 9, 10, 11, 12 mm

#### 16 Standard Sockets (3/8"):

3/8", 7/16", 1/2", 9/16", 5/8", 11/16", 3/4", 13/16"  
10, 11, 12, 13, 14, 15, 17, 19 mm

#### 6 Accessories:

Quick Release Ratchet 3/8" Drive

3" - 3/8" Drive Extension

6" - 3/8" Drive Extension

Universal Joint 3/8" Drive

3/8" Drive Adapter (3/8" F x 1/4" M)

Plastic Handle Driver 1/4"



Model No. TLV360







## 29-PIECE 1/2" DRIVE S.A.E./METRIC SOCKET SET

- Chrome vanadium steel for extra strength and durability
- Ratchets feature a quick-release button for easy changing of attachments
- Ratchet with contoured handle for comfort and added torque
- Chrome-plated sockets to resist rust
- 6-points sockets for snug fit
- Laser-marked socket size on each socket for easy identification
- Meets ANSI standards

### SET INCLUDES:

#### 24 Standard Sockets:

3/8", 7/16", 1/2", 9/16", 5/8", 11/16", 3/4", 13/16", 7/8", 15/16", 1"  
9, 10, 11, 12, 13, 14, 15, 16, 17, 18, 19, 20, 21 mm

#### 5 Accessories:

Quick Release Ratchet  
Extensions: 5" & 10"  
Universal Joint  
3/8" Drive Adapter (3/8" F x 1/2" M)

Model No. TLV359



## 24-PIECE 3/8" DRIVE METRIC SOCKET SET

- Chrome vanadium steel for extra strength and durability
- Ratchets feature a quick-release button for easy changing of attachments
- Ratchet with contoured handle for comfort and added torque
- Chrome-plated sockets to resist rust
- 6-points sockets for snug fit
- Laser-marked socket size on each socket for easy identification
- Meets ANSI standards

### SET INCLUDES:

#### 13 Standard Sockets:

7, 8, 9, 10, 11, 12, 13, 14, 15, 16, 17, 18, 19 mm

#### 8 Deep Sockets:

10, 11, 12, 13, 14, 15, 17, 19 mm

#### 3 Accessories:

Spark Plug Socket 16 mm  
Ratchet  
3" Extension

Model No. TLV358



## 22-PIECE 1/4" DRIVE S.A.E. SOCKET SET

- Chrome vanadium steel for extra strength and durability
- Ratchets feature a quick-release button for easy changing of attachments
- Ratchet with contoured handle for comfort and added torque
- Chrome-plated sockets to resist rust
- 6-points sockets for snug fit
- Laser-marked socket size on each socket for easy identification
- Meets ANSI standards



### SET INCLUDES:

#### 9 Standard Sockets:

3/16", 7/32", 1/4", 9/32", 5/16", 11/32", 3/8", 7/16", 1/2"

#### 7 Deep Sockets:

1/4", 9/32", 5/16", 11/32", 3/8", 7/16", 1/2"

#### 6 Accessories:

- 1 Quick-release Ratchet 1/4" Drive
- 1 Plastic Handle Driver 1/4" Drive
- 1 Drive Palm Ratchet
- 1 Universal Joint
- 2 Extensions: 2" & 6"

Model No. TLV356



## 20-PIECE 3/8" DRIVE S.A.E. SOCKET SET

- Chrome vanadium steel for extra strength and durability
- Ratchets feature a quick-release button for easy changing of attachments
- Ratchet with contoured handle for comfort and added torque
- Chrome-plated sockets to resist rust
- 6-points sockets for snug fit
- Laser-marked socket size on each socket for easy identification
- Meets ANSI standards



### SET INCLUDES:

#### 9 Standard Sockets:

3/8", 7/16", 1/2", 9/16", 5/8", 11/16", 3/4", 13/16", 7/8"

#### 8 Deep Sockets:

3/8", 7/16", 1/2", 9/16", 5/8", 11/16", 3/4", 13/16"

#### 3 Accessories:

- Quick Release Ratchet
- 2 Extensions: 2" & 3"

Model No. TLV357





### RATCHETS:

1/4" DRIVE, 5-1/2" L

Model No. TYL032



1/4" DRIVE QUICK-RELEASE, 5-3/4" L

Model No. TLV363



1/4" DRIVE QUICK-RELEASE  
WITH RUBBER GRIP, 6" L

Model No. TLV380



### DRIVE HINGE HANDLE

1/4" DRIVE, 5-3/4" L

Model No. TYL033



### PLASTIC HANDLE DRIVER

1/4" DRIVE, 6" L

Model No. TLV445



### EXTENSIONS

1/4" DRIVE, 2" L

Model No. TYK843



1/4" DRIVE, 4" L

Model No. TLV446



1/4" DRIVE, 6" L

Model No. TYL034

### DRIVE ADAPTOR

1/4" DRIVE, 3/8" M

Model No. TYL035



### UNIVERSAL JOINT

1/4" DRIVE, 1-1/2" L

Model No. TY0577





## 1/4" DRIVE S.A.E STANDARD LENGTH SOCKETS 6-POINT



Model No.	Hex Size"	Length"
TYK732	5/32	1
TYK733	3/16	1
TYK734	7/32	1
TYK735	1/4	1
TYK736	9/32	1
TYK737	5/16	1
TYK738	11/32	1
TYK739	3/8	1
TYK740	7/16	1
TYK741	1/2	1
TYK742	9/16	1

## 1/4" DRIVE S.A.E DEEP LENGTH SOCKETS 6-POINT

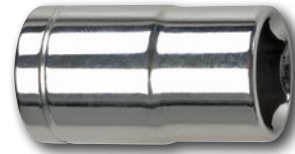

Model No.	Hex Size"	Length"
TYK791	5/32	2
TYK792	3/16	2
TYK793	7/32	2
TLV496	1/4	2
TYK794	9/32	2
TYK795	5/16	2
TYK796	11/32	2
TYK797	3/8	2
TYK798	7/16	2
TYK799	1/2	2
TYK800	9/16	2

## 1/4" DRIVE METRIC STANDARD LENGTH SOCKETS 6-POINT



Model No.	Hex Size mm	Length mm
TYK743	4	25
TYK744	4.5	25
TYK745	5	25
TYK746	5.5	25
TYK747	6	25
TYK748	7	25
TYK591	8	25
TYK750	9	25
TYK592	10	25
TYK752	11	25
TYK753	12	25
TYK754	13	25
TYK755	14	25

## 1/4" DRIVE METRIC DEEP LENGTH SOCKETS 6-POINT



Model No.	Hex Size mm	Length mm
TYK801	4	50
TYK802	4.5	50
TYK803	5	50
TYK804	5.5	50
TYK805	6	50
TLV497	7	50
TLV553	8	50
TYK806	9	50
TLV498	10	50
TYK807	11	50
TYK808	12	50
TYK809	13	50
TYK810	14	50



### RATCHETS

3/8" DRIVE, 7-7/8" L  
Model No. TNB484



3/8" DRIVE QUICK-RELEASE, 8" L  
Model No. TLV364



3/8" DRIVE QUICK-RELEASE  
WITH RUBBER GRIP, 8" L  
Model No. TLV381



### HINGE HANDLES

3/8" DRIVE, 9-1/2" L  
Model No. TYL037

3/8" DRIVE, 8-1/2" L  
Model No. TYL038



### EXTENSIONS

3/8" DRIVE, 3" L  
Model No. TLV365

3/8" DRIVE, 8" L  
Model No. TJZ226



3/8" DRIVE, 6" L  
Model No. TLV366

3/8" DRIVE, 12" L  
Model No. TYL040



### ADAPTORS

3/8" DRIVE, 1/4" M  
Model No. TYL041

3/8" DRIVE, 1/2" M  
Model No. TYK847



### SPARK PLUG SOCKETS

3/8" DRIVE, 5/8"  
Model No. TYL042

3/8" DRIVE, 13/16"  
Model No. TYL043



### UNIVERSAL JOINT

3/8" DRIVE, 2-1/4" L  
Model No. TYK844

## 3/8" DRIVE S.A.E STANDARD LENGTH SOCKETS 6-POINT



Model No.	Hex Size"	Length"
TLV367	1/4	1-1/8
TLV368	5/16	1-1/8
TYK756	3/8	1-1/8
TLV488	7/16	1-1/8
TMB048	1/2	1-1/8
TLV369	9/16	1-1/8
TYK757	5/8	1-1/8
TLV473	11/16	1-1/8
TLV474	3/4	1-1/8
TMB044	13/16	1-1/8
TMB045	7/8	1-1/8

## 3/8" DRIVE METRIC STANDARD LENGTH SOCKETS 6-POINT



Model No.	Hex Size mm	Length mm
TYK758	6	28
TYK759	7	28
TYK760	8	28
TYK761	9	28
TMB046	10	28
TYK762	11	28
TMB049	12	28
TMB052	13	28
TYK763	14	28
TYK764	15	28
TYK765	16	28
TYK766	17	28
TYK767	18	30
TMB054	19	30
TYL044	20	30
TYL045	21	30
TYL046	22	30
UAD527	23	30

## 3/8" DRIVE S.A.E DEEP LENGTH SOCKETS 6-POINT

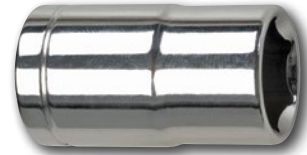

Model No.	Hex Size"	Length"
TYL048	1/4	2-1/2
TYK811	5/16	2-1/2
TYK812	3/8	2-1/2
TLV370	7/16	2-1/2
TLV371	1/2	2-1/2
TLV372	9/16	2-1/2
TMB047	5/8	2-1/2
TLV475	11/16	2-1/2
TLV373	3/4	2-1/2
TLV374	13/16	2-1/2
TLV476	7/8	2-1/2

## 3/8" DRIVE METRIC DEEP LENGTH SOCKETS 6-POINT



Model No.	Hex Size mm	Length mm
TYL050	6	63
TYK593	7	63
TYK813	8	63
TYK814	9	63
TYK815	10	63
TYK816	11	63
TMB053	12	63
TYK817	13	63
TYK818	14	63
TYK819	15	63
TYK820	16	63
TYK821	17	63
TYK822	18	63
TYK823	19	63
TYL052	20	63
TYL053	21	63
TYL054	22	63
TYL055	23	63





## RATCHETS

1/2" DRIVE, 10" L  
Model No. TLV375



1/2" DRIVE QUICK-RELEASE, 10" L  
Model No. TLV376



1/2" DRIVE QUICK-RELEASE WITH RUBBER GRIP, 10" L  
Model No. TLV382



## HINGE HANDLE

1/2" DRIVE, 14-1/4" L  
Model No. TTB977



## EXTENSIONS

1/2" DRIVE, 3" L  
Model No. TYL058



1/2" DRIVE, 5" L  
Model No. TLV377

1/2" DRIVE, 10" L  
Model No. TYK848



## ADAPTORS

1/2" DRIVE, 3/8" M  
Model No. TYL056

1/2" DRIVE, 3/4" M  
Model No. TYL057



## UNIVERSAL JOINT

1/2" DRIVE, 3" L  
Model No. TLV378

## SPEED HANDLE

1/2" DRIVE  
Model No. TNB489



## SPARK PLUG SOCKETS

1/2" DRIVE, 5/8" L  
Model No. TYK845

1/2" DRIVE, 13/16" L  
Model No. TYK846



## 1/2" DRIVE S.A.E STANDARD LENGTH SOCKETS 6-POINT



Model No.	Hex Size"	Length"
TYK768	3/8	1-1/2
TYK769	7/16	1-1/2
TTB978	1/2	1-1/2
TMB050	9/16	1-1/2
TYK771	5/8	1-1/2
TYJ946	11/16	1-1/2
TMB051	3/4	1-1/2
TYK648	13/16	1-1/2
TNB728	7/8	1-1/2
TYL059	15/16	1-9/16
TYK775	1	1-11/16
TYL060	1-1/16	1-13/16
TYL061	1-1/8	1-13/16
TYL062	1-3/16	1-13/16
TYL063	1-1/4	1-13/16

## 1/2" DRIVE METRIC STANDARD LENGTH SOCKETS 6-POINT



Model No.	Hex Size mm	Length mm
TYK776	10	38
TYK777	11	38
TYK778	12	38
TYK779	13	38
TYK780	14	38
TYK781	15	38
TYK782	16	38
TYK783	17	38
TYK784	18	38
TYK785	19	38
TYK786	20	38
TYK787	21	38
TYK788	22	38
TYK789	23	40
TYK790	24	40
TYL064	27	44
TYL065	30	44
TYL066	32	44

## 1/2" DRIVE S.A.E DEEP LENGTH SOCKETS 6-POINT



Model No.	Hex Size"	Length"
TYK824	7/16	3-1/16
TYK825	1/2	3-1/16
TYK826	9/16	3-1/16
TYK827	5/8	3-1/16
TYK828	11/16	3-1/16
TYK829	3/4	3-1/16
TYK830	13/16	3-1/16
TYK831	7/8	3-1/16
TLV379	15/16	3-1/16
TYL067	1	3-1/16
TYL068	1-1/16	3-1/16
TYK649	1-1/8	3-1/16
TYL069	1-1/4	3-1/16

## 1/2" DRIVE METRIC DEEP LENGTH SOCKETS 6-POINT



Model No.	Hex Size mm	Length mm
TYK832	10	77
TYK833	11	77
TYK834	12	77
TYK835	13	77
TYK836	14	77
TYL070	15	77
TYK837	16	77
TYK838	17	77
TYL071	18	77
TYK839	19	77
TYK840	20	77
TYK841	21	77
TYK842	22	77
TYL072	23	77
TYL073	24	77
TYL074	27	77
TYL075	30	77
TYL076	32	77

# VICES & CLAMPS

Clamps .....	49-50
Caulking Guns .....	49
Vises .....	51

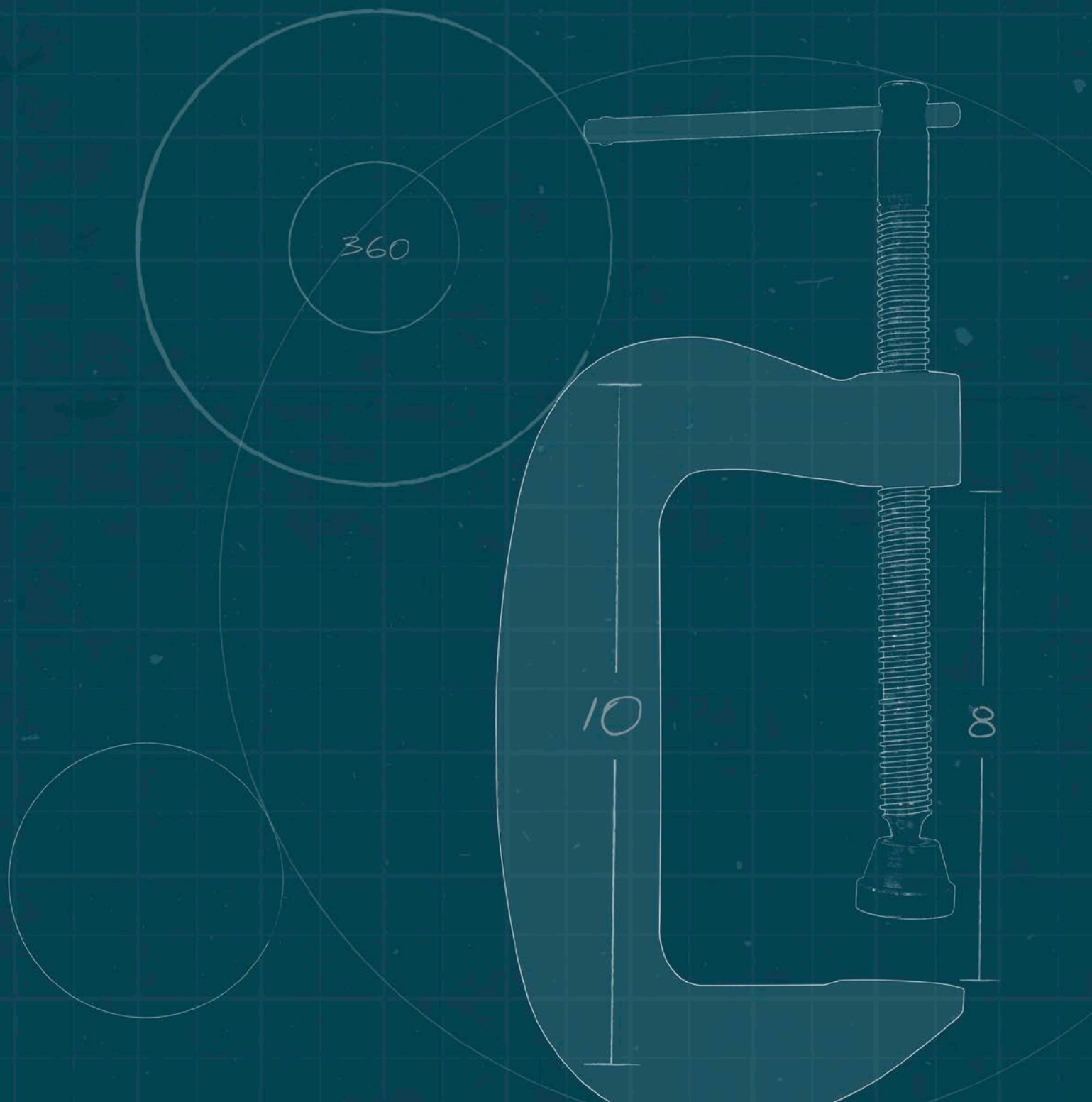

## PARALLEL JAW CLAMPS

- Aluminum die-cast handles have a quick adjustment mechanism for easy sizing
- Serrations in the steel rails engage with a hardened steel insert in the jaw to eliminate slipping
- Clamp jaws are encased in non-marring, glue resistant polypropylene casing
- Clamps up to 2.5 KN of pressure
- Throat depth: 3-1/3"
- Throat width: 1-1/2"
- Clamping Force: 562 lbs



Model No.	Clamping Capacity"
TYB500	24
TYB501	40

## C-CLAMPS

- Manufactured from SG iron with over 60000 PSI of tensile strength
- Swiveling pad adapts to the correct angle to apply even pressure on the work piece
- Textured powder coat finish on frame and black oxide finish on spindle increases corrosion resistance



Model No.	Clamping Capacity"	Throat Depth"	Clamping Force (lbs)
TYB502	2	1-5/8	800
TYB503	3	1-11/16	1000
TYB504	4	2-11/32	1200
TYB505	6	3	1400
TYB506	8	3-1/8	1700
TYB507	10	3-1/2	2200
TYB508	12	4	2500

## CAULKING GUN

- Compact size to fit in a tool box
- Skeleton design
- Comfortable operation
- Smooth hexagonal drive rod
- Size: 300 ml
- Seal-puncture tool
- Steady release
- Ladder hook



Model No. TYY156



# CLAMPS

- Commonly used clamps in manufacturing
- Perfect for holding work pieces in place
- Durable steel construction

## VERTICAL HOLD DOWN CLAMPS

- Includes bonded neoprene-tipped spindle and flanged washers
- Open arm provides adjustable spindle location

Model No.	Holding Cap. lbs.	A"	Dimensions				Base	Wt. lbs.
			B"	C"	D"	L"	x W"	
TLV625	200	4	2-1/2	1	1	1	x 1-3/4	0.34
TLV626	375	6	4-5/8	2-3/4	1-1/4	1-13/16	x 1-7/16	0.65
TLV627	600	8-1/8	4-13/16	3	1-3/4	1-7/8	x 2-1/2	1.25

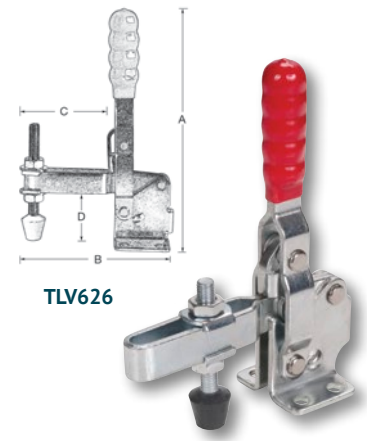

TLV626

## HORIZONTAL HOLD DOWN CLAMPS

- Includes bonded neoprene-tipped spindle and flanged washers
- Low height design is ideal when space is a concern
- Open arm provides adjustable spindle location

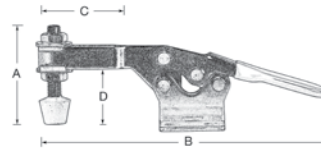

TLV628

Model No.	Holding Cap. lbs.	A"	Dimensions				Base	Wt. lbs.
			B"	C"	D"	L"	x W"	
TLV628	200	1-1/16	5-5/8	2-1/4	1	1-7/16	x 1-7/16	0.28
TLV629	500	1-13/16	6-3/4	2-11/16	15/16	1-3/8	x 1-1/2	0.52

## LATCH CLAMPS

- Commonly used to hold molds, dies, and jigs together
- Includes latch plate

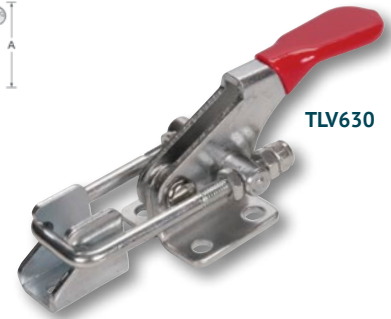
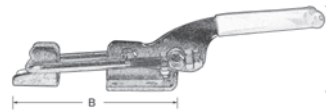

TLV630

Model No.	Holding Cap. lbs.	Dimensions			Base	Wt. lbs.
		A"	B"	L"	x W"	
TLV630	360	1-1/4	4	1-1/16	x 1	0.16
TLV631	700	1-5/8	6-7/8	1-1/2	x 1-11/16	0.55

## STRAIGHT LINE CLAMPS

- Commonly used in assembly operations or with welding jigs

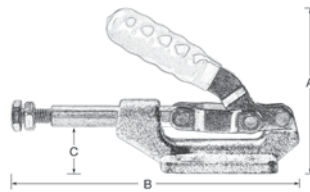

TLV632

TLV633

Model No.	Holding Cap. lbs.	Dimensions				Base	Wt. lbs.
		A"	B"	C"	L"	x W"	
TLV632	600	3	5-1/4	3-1/4	1-7/8	x 1-1/4	0.80
TLV633	300	4-5/16	4-1/2	-	-	-	0.42

### HEAVY-DUTY BENCH VISES W/FIXED BASE

- 80000 PSI industrial grade ductile iron
- Built in pipe jaws hold round objects
- Hardened anvil striking surface used for forming & shaping
- Safety locking plate in base prevents the vise from slippage

Model No.	Jaw Width"	Jaw Opening"	Throat Depth"	Mount Type
TYL093	4	4-1/2	2-7/10	Fixed
TYL094	5	5-1/2	3-3/10	Fixed
TYL095	6	6-1/2	3-1/2	Fixed
TYL096	8	8-1/2	4	Fixed

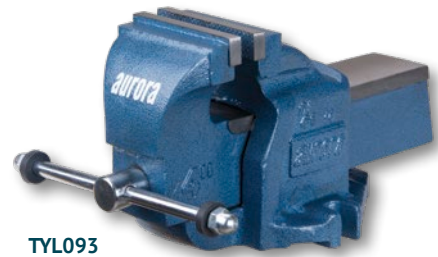

TYL093

### HEAVY-DUTY BENCH VISES W/SWIVEL BASE

- 80000 PSI industrial grade ductile iron
- Built in pipe jaws hold round objects
- Hardened anvil striking surface used for forming & shaping
- Safety locking plate in base prevents the vise from slippage

Model No.	Jaw Width"	Jaw Opening"	Throat Depth"	Mount Type
TYL098	4	4-1/2	2-1/2	Swivel
TYL099	5	5-1/2	3	Swivel
TYL100	6	6-1/2	3-2/5	Swivel
TYL101	8	8-1/2	3-4/5	Swivel



TYL098

### MULTI-PURPOSE BENCH VISE

- Heavy duty casting for demanding applications
- Rotating head for gripping at any angle
- Permanent pipe jaws hold round objects
- Hardened anvil striking surface used for forming & shaping
- Safety locking plate in base prevents the vise from slippage

Model No.	Jaw Width"	Jaw Opening"	Throat Depth"	Mount Type
TYL102	5	5-1/2	3-1/10	Swivel

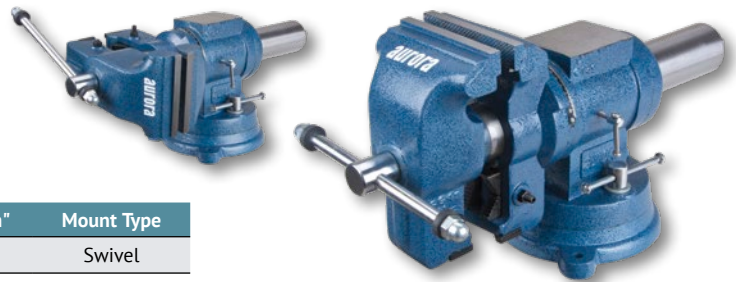

### OFF-SET BENCH VISE

- Heavy duty industrial grade vise
- V notched hardened jaws for vertical gripping
- Ideal for tall work pieces
- Hardened anvil striking surface used for forming & shaping
- Safety locking plate in base prevents the vise from slippage

Model No.	Jaw Width"	Jaw Opening"	Throat Depth"	Mount Type
TYL103	6	6-1/2	4	Fixed

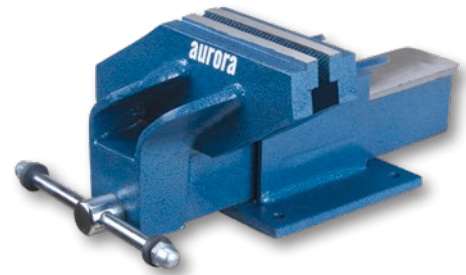

### UTILITY WORKSHOP VISE

- 80000 PSI industrial grade ductile iron
- Built in pipe jaws hold round objects
- Hardened anvil striking surface used for forming & shaping
- Safety locking plate in base prevents the vise from slippage

Model No.	Jaw Width"	Jaw Opening"	Throat Depth"	Mount Type
TYL097	6	6-1/2	3-2/5	Swivel





# AIR TOOLS

Sanders, Screwdrivers and Chippers.....	53
Impact Wrenches.....	54-55
Ratchet Wrenches.....	55
Grinders.....	56
Cut-off Tools & Drills.....	57
Filter Regulator Lubricators.....	58-59
Air Blow Guns.....	60-61
Hose Reels & Accessories.....	62

## DUAL-ACTION ORBIT SANDERS

- Dual-action, compact and lightweight design
- Lever throttle offers one hand control
- Low vibration for swirl-free finishes
- Non-vacuum model
- Free speed: 10000 RPM
- Average Air Consumption: 9 CFM
- Hose air inlet: 1/4" - 18 NPT
- Units come with a stick-on pad
- Hose size: 3/8" (9.5 mm)
- Horse power: 0.35 HP
- Vibration less than 0.80 m/s<sup>2</sup>
- Sound pressure Level: 78 (dBA)



### SANDER

Model No.	Dia."	Overall Length"	Weight lbs.
TLZ142	5	6-1/2	1.8
TLZ143	6	7	1.9

### SANDER PADS

Model No.	Description
TLZ472	Stick-on Pad For TLZ142
TLZ473	Hook-up Pad For TLZ142
TLZ474	Stick-on Pad For TLZ143
TLZ475	Hook-up Pad For TLZ143

## 1/4" AIR SCREWDRIVER

- Durable steel body
- Forward-reverse switch
- Low noise, low vibrations
- Overall length: 7 1/2"
- Weight: 2.4 lbs.
- Horse power: 0.5 HP

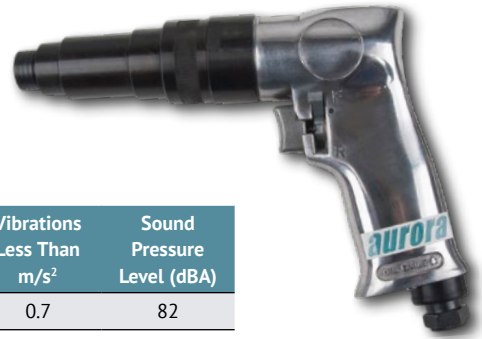

Model No.	Free Speed RPM	Torque Range ft.-lbs.	Average Consumption CFM	Air Inlet	Hose Size	Vibrations Less Than m/s <sup>2</sup>	Sound Pressure Level (dBA)
TLV495	1800	45-115	6	1/4" - 18 NPT	3/8" (9.5 mm)	0.7	82

## AIR FLUX CHIPPER

- Lightweight and compact design permits increased operator efficiency
- Paddle style trigger offers better speed control and precision
- Low noise, low vibration
- Durability and longer life
- Comes with 35 mm flat chisel
- Overall length: 10-1/4"
- Weight: 4.1 lbs.

### AVAILABLE ACCESSORIES:

20 mm flat chisel - **Model No. TLZ134**

35 mm flat chisel - **Model No. TLZ135**

Moil point - **Model No. TLZ136**



## AIR NEEDLE SCALER

- Lightweight compact design permits increased operator efficiency
- Paddle style trigger offers better speed control and precision
- Low noise, low vibration
- Durability and longer life
- Comes with 19 needles
- Overall length: 16"
- Weight: 6.1 lbs.

### REPLACEMENT NEEDLES:

7" Long, 19/pack - **Model No. TLZ132**



Model No.	Description	Stroke	Blows per min. BPM	Average Consumption CFM	Air Inlet	Hose Dia.	Vibrations Less Than m/s <sup>2</sup>	Sound Pressure Level (dBA)
TLZ133	Air Flux Chipper	1-1/2" (38 mm)	4400	9	1/4" - 18 NPT	3/8" (9.5 mm)	10.2	92
TLZ131	Air Needle Scaler	1-1/2" (38 mm)	4000	9	1/4" - 18 NPT	3/8" (9.5 mm)	10.2	104.3



## 3/4" HEAVY-DUTY AIR IMPACT WRENCH

### Model No. THZ672

- Twin hammer impact mechanism
- Three-step forward/reverse regulator allows the operator to adjust the power to the job
- Rear exhaust directs air away from work piece and operator
- Ergonomically designed to reduce operator fatigue
- Special heat-treatment of major parts and anvil for long life
- Soft rubber grip handle reduces fatigue
- Weight: 11 lbs.



THZ672

## 1/2" HEAVY-DUTY AIR IMPACT WRENCH

### Model No. THZ673

- Pin-clutch hammer mechanism
- Built-in regulator to prevent over-torquing
- Low noise, low vibration
- Forward-reverse switch, and high-low speed regulator
- Durability and longer life
- Weight: 5 lbs.



THZ673

Model No.	Square Drive	Bolt Capacity	Free Speed RPM	Torque Range ft.-lbs.	Average Air Consumption CFM	Air Inlet	Hose Dia.	Vibrations Less Than m/s <sup>2</sup>	Sound Pressure Level (dBA)
THZ672	3/4" (19 mm)	1" (25.4 mm)	4600	565-1100	9	1/4" - 18 NPT	3/8" (9.5 mm)	6.1	90
THZ673	1/2" (12.7 mm)	5/8" (15.9 mm)	7000	25-320	12	1/4" - 18 NPT	3/8" (9.5 mm)	3.1	94

## HEAVY-DUTY AIR IMPACT WRENCHES

- Ergonomic composite handle helps reduce operator fatigue and insulate vibration
- Exhaust air outlet directs air away from operator
- Forward-reverse switch, and high-low speed regulator
- Low noise, low vibration
- **Overall length:**  
TLZ137 - 7"  
TLZ138 - 7-3/4"
- **Weight:**  
TLZ137 - 2.8 lbs.  
TLZ138 - 4.6 lbs.



TLZ137

Model No.	Square Drive	Bolt Capacity	Free Speed RPM	Torque Range ft.-lbs.	Average Air Consumption CFM	Air Inlet	Hose Dia.	Vibrations Less Than m/s <sup>2</sup>	Sound Pressure Level (dBA)
TLZ137	3/8" (9.53 mm)	1/2" (13 mm)	10000	90-280	10.6	1/4" - 18 NPT	3/8" (9.5 mm)	3.7	91.5
TLZ138	1/2" (12.7 mm)	5/8" (16 mm)	10000	400-1000	13.7	1/4" - 18 NPT	3/8" (9.5 mm)	6.0	94



## 3/4" HEAVY-DUTY AIR IMPACT WRENCH

- Ergonomic composite handle and body helps reduce operator fatigue and insulate vibration
- Exhaust air outlet directs air away from operator
- Forward-reverse switch, and high-low speed regulator
- Overall length: 8"
- Weight: 5 lbs.

Model No.	Square Drive	Bolt Capacity	Free Speed RPM	Torque Range ft-lbs.	Average Air Consumption CFM	Air Inlet	Hose Dia.	Vibrations Less Than m/s <sup>2</sup>	Sound Pressure Level (dBA)
TLZ139	3/4" (19 mm)	1" (26 mm)	9000	450-1000	13.7	1/4" - 18 NPT	3/8" (9.5 mm)	9.2	95.9



## 1/4" STUBBY TYPE AIR RATCHET WRENCH

- Variable speed, reversible
- Paddle style trigger provides better speed control
- Powerful tool in a compact design
- Composite grip helps reduce operator fatigue and insulate vibration
- Overall length: 7-1/4"
- Weight: 1.4 lbs.

Model No.	Square Drive	Free Speed RPM	Torque Range ft-lbs.	Average Air Consumption CFM	Air Inlet	Hose Dia.	Vibrations Less Than m/s <sup>2</sup>	Sound Pressure Level (dBA)
TLZ140	1/4" (6.35 mm)	230	5-30	3	1/4" - 18 NPT	5/16" (8 mm)	4.4	87



THZ671

## HEAVY-DUTY AIR RATCHET WRENCHES

- Variable speed, reversible
- Paddle style trigger provides better speed control
- Composite handle helps insulate vibration
- Ideal for automotive and industrial fastener removal and installation work
- Weight: 2.6 lbs.



THZ680

Model No.	Square Drive Size	Free Speed RPM	Torque Range ft-lbs.	Average Air Consumption CFM	Air Inlet	Hose Dia.	Horse Power HP	Vibration Less Than m/s <sup>2</sup>	Sound Pressure Level (dBA)
THZ671	3/8" (9.5 mm)	175	5-75	3	1/4" - 18 NPT	3/8" (9.5 mm)	0.45	1.0	78
THZ680	1/2" (12.7 mm)	175	5-75	3	1/4" - 18 NPT	3/8" (9.5 mm)	0.45	1.0	83

## 5" PNEUMATIC ANGLE GRINDER

- 5/8" - 11 UNC spindle
- Powerful twin-chamber motor delivers much higher torque
- Ergonomic grip handle reduces operator fatigue
- Textured non-slip composite grip handle helps reduce vibration
- Side handle and wrenches included
- Weight: 3.1 lbs.



Model No.	Grinding Wheel	Spindle Thread	Free Speed RPM	Average Air Consumption CFM	Air Inlet	Hose Size	Vibrations Less Than m/s <sup>2</sup>	Sound Pressure Level (dBA)
THZ674	5" (127 mm)	5/8" (15.9 mm)	10000	5	1/4" - 18 NPT	3/8" (9.5 mm)	3.1	83

## 1/4" PNEUMATIC MINI DIE GRINDER

- Ergonomic composite grip handle helps reduce operator fatigue and vibration
- Power/speed regulator allows for easy RPM adjustment
- Twin-bearing design for smooth operation
- Wrenches included
- Weight: 0.9 lbs.



Model No.	Collet Size	Free Speed RPM	Average Air Consumption CFM	Air Inlet	Hose Size	Horsepower HP	Vibrations Less Than m/s <sup>2</sup>	Sound Pressure Level (dBA)
THZ678	1/4" (6.4 mm)	25 000	3	1/4" - 18 NPT	3/8" (9.5 mm)	0.35	0.1	83

## 1/4" PNEUMATIC ANGLE DIE GRINDER

- Ergonomic composite grip handle helps reduce operator fatigue and vibration
- Power/speed regulator allows for easy RPM adjustment
- Twin-bearing design for smooth operation
- Wrenches included
- Weight: 1.7 lbs.



Model No.	Collet Size	Free Speed RPM	Average Air Consumption CFM	Air Inlet	Hose Size	Horsepower HP	Vibrations Less Than m/s <sup>2</sup>	Sound Pressure Level (dBA)
THZ679	1/4" (6.4 mm)	18 000	3	1/4" - 18 NPT	3/8" (9.5 mm)	0.45	0.1	80

## 3" AIR CUT-OFF TOOL

- Ergonomic composite grip handle helps reduce operator fatigue and insulate vibration
- Power/speed regulator allows for easy RPM adjustment
- Twin-bearing design for smooth operation and cut off
- Wrench and Hex Key included to lock/unlock the disc
- Weight: 1.8 lbs.



Model No.	Cutting Wheel	Free Speed RPM	Average Air Consumption CFM	Air Inlet	Hose Size	Horsepower HP	Vibrations Less Than $m/s^2$	Sound Pressure Level (dBA)
THZ677	3" (76.2 mm)	21 000	3	1/4" - 18 NPT	3/8" (9.5 mm)	0.45	0.2	81

## 3/8" AIR REVERSIBLE DRILL

### Model No. THZ675

- Ergonomic composite housing
- Textured non-slip rubber grip reduces vibration
- Two-gear structure runs smoothly
- Weight: 2 lbs.



## 1/2" AIR REVERSIBLE DRILL

### Model No. THZ676

- Ergonomic composite housing
- Textured non-slip rubber grip reduces vibration
- Two-gear structure runs smoothly
- Side handle included
- Weight: 3 lbs.

Model No.	Chuck Size	Spindle Thread	Free Speed RPM	Average Air Consumption CFM	Air Inlet	Hose Size	Vibrations Less Than $m/s^2$	Sound Pressure Level (dBA)
THZ675	3/8" (9.5 mm)	3/8" - 24 Threads	1800	4	1/4" - 18 NPT	3/8" (9.5 mm)	0.10	88
THZ676	1/2" (12.7 mm)	3/8" - 24 Threads	450	4	1/4" - 18 NPT	3/8" (9.5 mm)	0.15	88



# FILTER REGULATOR LUBRICATORS

## SUGGESTIONS FOR INSTALLING FRL & DRAINS

The filter, regulator, and lubricator should be installed in the order shown in the illustration. Individual take-off lines to the FRL unit and air tool(s) should be from the top of the compressed air line. To trap and expel water, sludge, and other contaminants which may collect on the bottom of the air line, a mechanical drain should be used. Mechanical drains should be installed at low points in the piping system and at the far end of the distribution system.

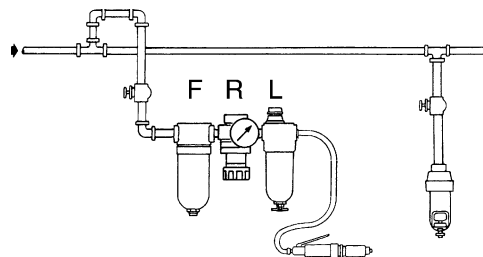

## MODULAR FILTER, REGULATOR & LUBRICATOR (GAUGE INCLUDED)

- Components are attached in series using spacers and piping adapters, which make the individual components easily removable and mountable without disturbing the pipe line
- Comes complete with wall mounting bracket
- Air filter, regulator and lubricator come with NPT threads and gauge
- Operating Pressure: 7-145 PSI



Model No.	Connection Size	Max. Air Flow	Bowl Capacity fl. oz.	Filter Bowl Capacity oz.
<b>POLYCARBONATE BOWL WITH STEEL BOWL GUARD</b>				
TY181	1/4" NPT	18 SCFM @ 105 PSI	0.68	0.30
TY182	3/8" NPT	71 SCFM @ 105 PSI	1.92	1.08
TY183	1/2" NPT	123 SCFM @ 105 PSI	5.17	1.50
<b>METAL BOWL</b>				
TY184	3/4" NPT	123 SCFM @ 105 PSI	6.8	5.60
TY185	1" NPT	175 SCFM @ 105 PSI	6.8	5.60

## MODULAR FILTER/REGULATOR & LUBRICATOR (GAUGE INCLUDED)

- Space-saving, two-piece combination is a popular air preparation unit
- Attached in series using spacers and piping adapters, which make the two components easily removable and mountable without disturbing the pipe line
- Come complete with a wall mounting bracket
- Operating Pressure: 7-145 PSI
- Bowl Material: Polycarbonate bowl with steel bowl guard



Model No.	Connection Size	Max. Air Flow	Bowl Capacity fl. oz.	Filter Bowl Capacity oz.
TY178	1/4" NPT	18 SCFM @ 105 PSI	0.68	0.30
TY179	3/8" NPT	44 SCFM @ 105 PSI	1.93	1.08
TY183	1/2" NPT	99 SCFM @ 105 PSI	5.17	1.50

## MODULAR AIR LUBRICATOR

- Used to feed lubricants to pneumatic equipment and maintain a constant oil-to-air density over a wide range of flow
- Fog/Micro Mist type, up to 50' pipe runs
- The head is fitted with oil drop indicator, oil drop controller and oil filling plug
- Designed for best performance with 32-grade oil
- Comes with NPT threads

Model No.	Connection Size	Max. Air Flow	Bowl Capacity fl. oz.	Max. PSI
<b>MODULAR - POLYCARBONATE BOWL W/STEEL BOWL GUARD</b>				
TY170	1/4" NPT	48 SCFM @ 90 PSI	0.68	145
TY171	3/8" NPT	106 SCFM @ 90 PSI	1.98	145
TY172	1/2" NPT	200 SCFM @ 90 PSI	5.13	145
<b>VERTICAL - METAL BOWL</b>				
TY173	3/4" NPT	255 SCFM @ 90 PSI	6.8	290
TY174	1" NPT	318 SCFM @ 90 PSI	6.8	290



## MODULAR AIR FILTER/REGULATOR (GAUGE INCLUDED)

- Filter-Regulator combination is the most popular air preparation units, assembled together to form a single unit
- Regulators are used to maintain a steady outlet pressure, unaffected by variations or fluctuations in the inlet pressure
- Filter used to separate dust, dirt, moisture and other contaminants from compressed air
- Press-type manual drain with nighttime drain feature, which automatically drains off the bowl once the compressed air supply to the filter is switched off
- Filter has sintered bronze, 40-micron filtering element
- Comes with NPT threads and gauge
- Max. PSI: 145 PSI
- Bowl Material: Polycarbonate bowl with steel bowl guard

Model No.	Connection Size	Max. Air Flow	Bowl Capacity fl. oz.
TY175	1/4" NPT	20 SCFM @ 105 PSI	0.3
TY176	3/8" NPT	64 SCFM @ 105 PSI	1.08
TY177	1/2" NPT	106 SCFM @ 105 PSI	1.5



## MODULAR AIR FILTER

- Used to separate dust, dirt, moisture and other contaminants from compressed air
- Sintered bronze, 40-micron filtering element
- Designed with a separator and shield for efficient moisture separation
- Press-type manual drain with nighttime drain feature, which automatically drains off the bowl once the compressed air supply to the filter is switched off
- Comes with NPT threads
- Drain Type: Semi-Automatic
- Material Filtered: Combination
- Filtration Size (Microns): 40 Microns

Model No.	Connection Size	Max. PSI	Bowl Material
<b>MODULAR</b>			
TY165	1/4" NPT	145	Polycarbonate
TY166	3/8" NPT	145	Polycarbonate
TY167	1/2" NPT	145	Polycarbonate
<b>VERTICAL</b>			
TY168	3/4" NPT	290	Metal
TY169	1" NPT	290	Metal



## MODULAR AIR REGULATOR (GAUGE INCLUDED)

- Regulators are used to maintain a steady outlet pressure, unaffected by variations or fluctuations in the inlet pressure
- Regulators step down the air line pressure and can be set at any desired pressure below the inlet air pressure
- Designed with a non-raising "Press to Lock" adjustment knob for locking at any set pressure
- These can be installed in any position and need not be vertically mounted
- Comes with NPT threads and gauge
- Max. PSI: 220 PSI

Model No.	Connection Size	Max. Air Flow
TY160	1/4" NPT	21 SCFM @ 105 PSI
TY161	3/8" NPT	88 SCFM @ 105 PSI
TY162	1/2" NPT	140 SCFM @ 105 PSI
TY163	3/4" NPT	175 SCFM @ 105 PSI
TY164	1" NPT	210 SCFM @ 105 PSI





## AIR BLOW GUN WITH BRASS SAFETY NOZZLE

- Contoured design fits comfortably in the operator's hand
- Brass tip increases air flow
- Cushioned thumb lever
- Hook design allows for easy and convenient storage
- 1/4" (F) - 18 NPT Air inlet

**Model No. TLV118**



## AIR BLOW GUN

- Contoured body fits comfortably in the operator's hand
- The body is made to protect the palm of the hand against the connection fittings
- Curved tip 5" long
- 1/4" (F) - 18 NPT Air inlet

**Model No. TLZ146**



## BLOW GUN KIT - 5 PCS

- Contoured design fits comfortably in the operator's hand
- Chrome plated finish
- Large hanging hook
- 1/4" (F) - 18 NPT Air inlet
- Comes with five tips: Non-marring soft rubber tip, large needle tip, narrow needle tip, inflating needle tip and metal tip

**Model No. TLZ147**



## HEAVY-DUTY AIR BLOW GUN KIT - 7 PCS

- Impact and weather resistant nylon body
- Ergonomic soft rubber grip
- Variable speed trigger controls the amount of air dispensed
- Brass threaded air inlet ensures that threads do not shear
- Silent operation with noise level under 80 dB
- 1/4" (F) - 18 NPT air inlet
- Maximum working pressure: 235 PSI
- Operating temperature: -10° C to 70° C

### KIT INCLUDES:

- Heavy-duty safety blow gun w/ 4-1/2" long S.S. nozzle
- 4" protective shield provides safety from projectiles
- Soft rubber star tip nozzle for use on delicate materials
- Venturi nozzle for turbo charging output
- 1/2" rubber tip for blowing out lines and cavities
- 1" rubber tip for blowing out lines and cavities
- 1-3/8" rubber tip for blowing out lines and cavities

**Model No. TYB523**

# HEAVY-DUTY AIR BLOW GUNS

- Impact and weather resistant nylon body
- Ergonomic soft rubber grip
- Variable speed trigger controls the amount of air dispensed
- Brass threaded air inlet ensures that threads do not shear

- Silent operation with noise level under 80 dB
- 1/4" (F) – 18 NPT air inlet
- Maximum working pressure: 50-235 PSI
- Operating temperature: -10° C to 70° C

## HEAVY-DUTY BLOW GUN

- Noise level at 100 PSI: 77 dB
- Standard tip

Model No. TYB519



## HEAVY-DUTY SAFETY BLOW GUN

- Comes with snub nose rubber tip
- Noise level at 100 PSI: 77 dB
- Standard(s) Met: OSHA STD 1-13.1

Model No. TYB520



## HEAVY-DUTY SAFETY BLOW GUN W/STAINLESS STEEL NOZZLE

- Comes with 4-1/2" long stainless steel nozzle
- Noise level at 100 PSI: 80 dB
- Standard(s) Met: OSHA STD 1-13.1

Model No. TYB521



## HEAVY-DUTY SAFETY BLOW GUN W/STAINLESS STEEL NOZZLE & SILENCER

- Comes with 5-1/2" long stainless steel nozzle and a silencer
- Noise level at 100 PSI: 75 dB
- Standard(s) Met: OSHA STD 1-13.1

Model No. TYB522







## HOSE REELS

- Heavy-duty, reinforced steel stampings for increased strength
- Compact design allows reels to fit in tight locations
- Multi-position guide arm for multiple mounting options
- Kinkless, oil resistant high quality hose
- Spring rewind features long life spring with declutching arbour
- Durable, corrosion-resistant powder coat paint
- Good for air and water

Model No.	Drive Type	Hose I.D."	Hose Length'	Max PSI	Hose Outlet" (M) NPT	Reel Inlet" (F) NPT	Dimensions D" x W" x H"	Wt. lbs.
TLZ482	Spring	1/4	35	300	1/4	3/8	15-1/2 x 6 x 14	26.6
TLZ483	Spring	3/8	25	300	1/4	3/8	15-1/8 x 6 x 13-7/8	26.2
TLZ484	Spring	3/8	35	300	1/4	3/8	17-1/2 x 6 5/8 x 16-1/2	34.7
TLZ485	Spring	3/8	50	300	1/4	3/8	20 x 1/2 x 18-3/8	40.3
TLZ486	Spring	1/2	50	300	1/2	1/2	20-1/4 x 6-5/8 x 17-7/8	44.3

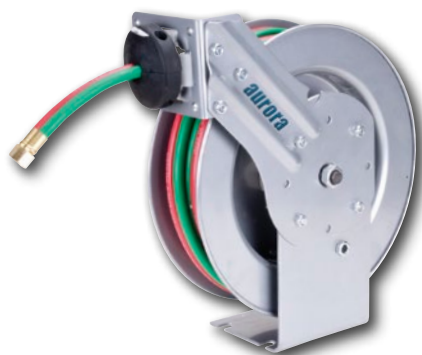

## WELDING HOSE REELS

- Heavy-duty, reinforced steel stampings for increased strength
- Compact design allows reels to fit in tight locations
- 1/4" oxygen and acetylene twin hose
- Leak proof double O-ring seals
- Multi-position guide arms for multiple mounting options
- Kinkless, oil resistant high quality hoses
- Spring rewind features long life spring with declutching arbor
- Durable, corrosion-resistant powder coat paint

Model No.	Drive Type	Hose I.D."	Hose Length'	Max PSI	Oxygen Inlet and Outlet	Acetylene Inlet and Outlet	Dimensions D" x W" x H"	Wt. lbs.
TLZ487	Spring	1/4	25	300	9/16" x 18 UNF (Female)	9/16" x 18 UNF (Female)	14-3/4 x 8 x 13-5/8	25.9
TLZ488	Spring	1/4	50	300	9/16" x 18 UNF (Female)	9/16" x 18 UNF (Female)	20-1/2 x 8-5/8 x 20-1/2	42.2

## AIR HOSE NYLON COILS WITH FITTINGS

- Light and easy to handle
- High impact and abrasion resistance
- Excellent elastic memory, can be stretched repeatedly yet return to original shape for convenient storage
- Temperature range: -5°C to 70°C
- Colour: High visibility yellow



Model No.	Hose I.D." NPT"	Length'	Max. Working Pressure PSI
TLZ150	1/4 1/4	25	200
TLZ151	1/4 1/4	50	200
TLZ152	3/8 3/8	25	300
TLZ153	3/8 3/8	50	300

## 5-PIECE 1/4" PLUG QUICK COUPLER KIT

### SET INCLUDES:

- 1, 1/4" Quick coupler
- 1, 1/4" Female plug
- 3, 1/4" Male plugs

Model No. TLZ148



## 3/8" AIR HOSE REPAIR KIT

### SET INCLUDES:

- 1, Hose Splicer
- 1, Hose End
- 3, Hose Clamps

Model No. TLZ149



# LUBRICATION TOOLS

- Grease Guns..... 64-65
- Grease Pumps ..... 66
- Oil Cans & Funnels ..... 67
- Grease Gun Accessories..... 68-69
- Grease Fittings ..... 70

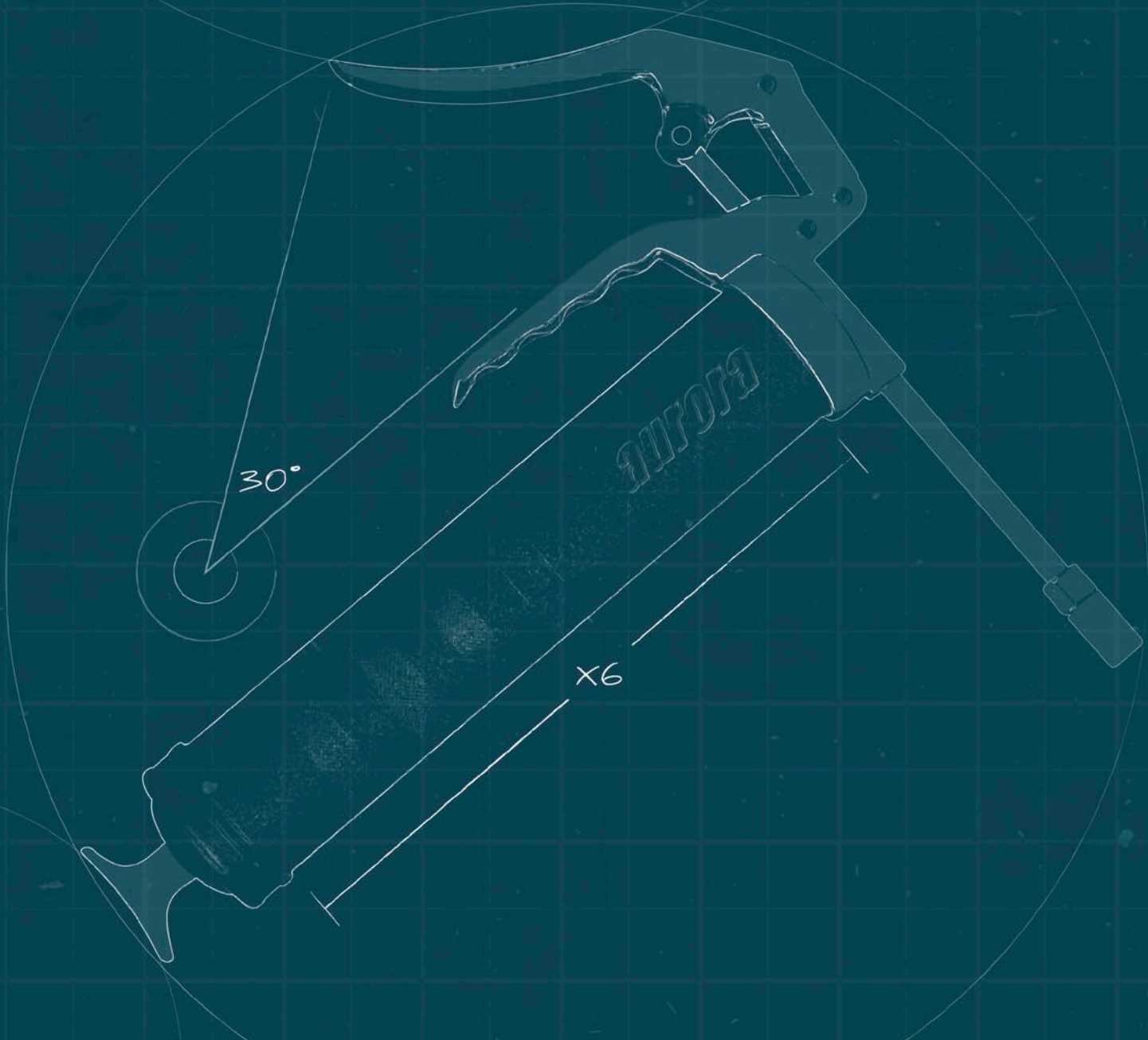

## STANDARD-DUTY LEVER GREASE GUN

- Designed for use in general lubrication and daily maintenance work
- Capacity: 14 oz. (400 g) grease cartridge or suction fill
- Comes with 6" steel extension and 4-jaw coupler with ball check
- Develops 6000 PSI

Model No. AC472



## HEAVY-DUTY LEVER GREASE GUN

- Designed for punishing day-in and day-out heavy industrial applications
- Capacity: 14 oz. (400 g) grease cartridge, filler pump or suction fill
- Built-in variable stroke feature for greasing fittings with limited access
- Die cast grease gun head fitted with bulk loader and air bleeder
- Extra heavy-duty zinc plated lever handle with ergonomic rubber grip
- Comes with 6" steel extension and 4-jaw coupler with ball check
- Develops 10000 PSI

Model No. AC473



## HEAVY-DUTY PISTOL GREASE GUNS

- Designed for use in general confined spaces or where access to grease nipples is restricted
- Capacity: 14 oz. (400 g) grease cartridge or suction fill
- Heavy-duty die cast grease gun head
- Develops 5000 PSI
- AC475 comes with 5" steel extension and 4-jaw coupler with ball check
- AC476 comes with 18" flexible hose and 4-jaw coupler with ball check

Model No. AC475

Model No. AC476

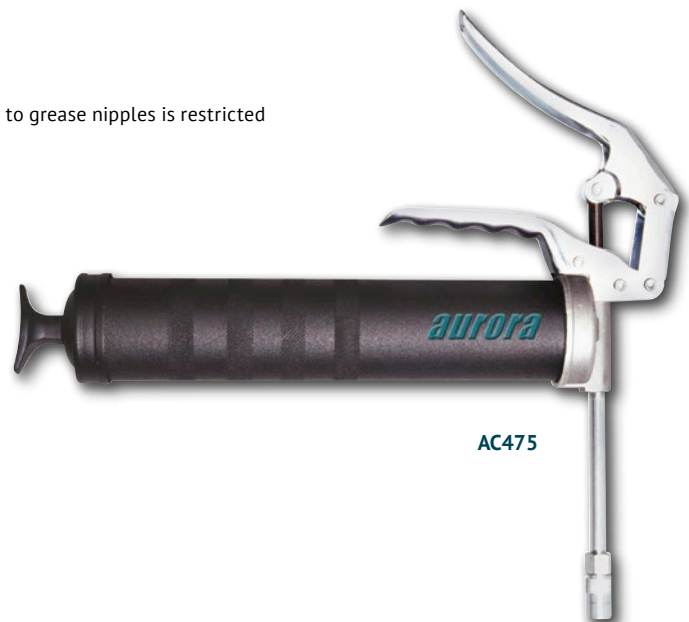

AC475

## DELUXE MINI PISTOL GREASE GUNS

- Die cast grease gun head with dual discharge ports for use with steel extension as well as a flex hose
- Single-hand operated pistol grip
- Develops 3500 PSI
- Capacity: 3 oz. grease cartridge or bulk fill
- Textured zinc plated finish for non-slip grip
- Comes with 4" steel extension and professional 4-jaw coupler with ball check

**Model No. AC477**

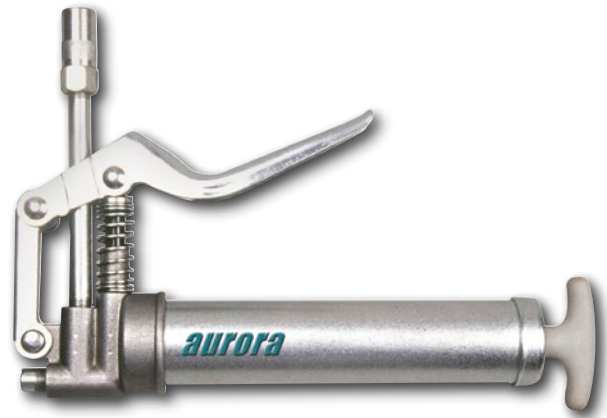

## AIR OPERATED GREASE GUNS

- Ideal for use in factory maintenance
- Capacity: 14 oz. (400g) grease cartridge or suction fill
- Single shot of grease discharge with every press of the trigger
- Air operating range: 40 - 120 PSI
- Comes with 6" steel extension and professional 4-jaw coupler with ball check

**Model No. AC478**

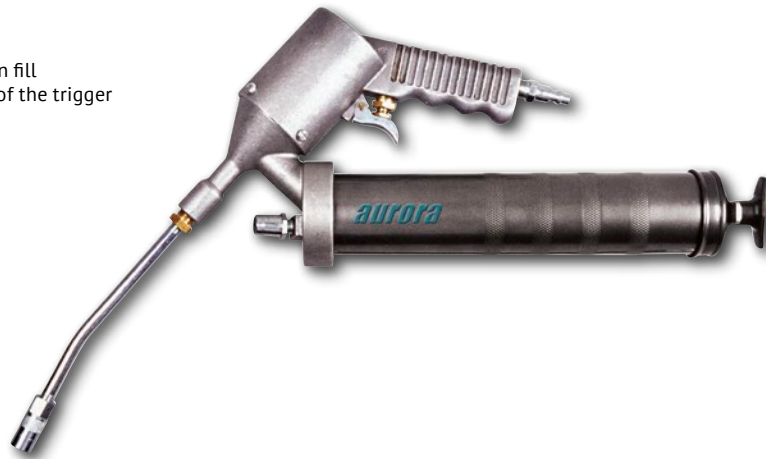

## SUCTION GUNS

- A rugged transfer gun designed for use with gear oils to get them both into and out of gear boxes, transfer cases and differentials
- Comes with 12" flexible vinyl hose
- Capacity: 16 oz.

**Model No. AC494**



## MINI GREASE GUNS

- Designed for use in general confined spaces, or where access to grease nipples is restricted
- Single-hand-operated push type grip
- Develops 1400 psi
- Capacity: 3 oz. (85 g)

**Model No. AD084**







## GREASE FILLER PUMPS

- An ideal grease filling solution to easily load bulk or combination grease guns from bulk grease pails
- No mess or waste
- Full economy in buying bulk grease
- Pail capacity: 5 gallons
- Rubber lining follower plate for use with most bucket types

**Model No. AD383**



## BUCKET GREASERS

- High-volume, high-pressure grease pump
- Uses low cost bulk grease
- Delivers 3 g/stroke or 1 oz. in less than 10 strokes at pressures up to 2000 PSI
- Comes with 22-lb. built-in steel grease bucket

**Model No. AC495**



## AIR OPERATED GREASE PUMPS

- Ideal for applications having continuous need for high-pressure grease
- 50:1 ratio pump
- Recommended air pressure between 60 and 125 PSI
- Air inlet: 1/4" NPT (female)
- Grease outlet: 1/4" NPT (female)
- Fits 5-gallon and 16-gallon pails
- Comes with 12" diameter drum cover, rubber-lined follower plate, 7' of high pressure grease hose, Z swivel and grease control valve

**Model No. AC496** For 25-50 lbs. Pails

**Model No. AC497** For 120 lbs. Pails



## PREMIUM GREASE CONTROL VALVES

- For use with power-operated equipment
- Provides continuous grease flow with trigger fully depressed
- Inlet thread specification: 1/4" NPT (female)
- Outlet thread specification: 1/8" NPT (female)
- 7500 PSI
- Comes with 6" steel extension and heavy-duty coupler

**Model No. AC498**

## OIL CANS

- Seamless oil can body is drawn from heavy-gauge tin-coated sheet
- Premium powder-coated finish
- Steel pump



AC588



AC514



AC590

Model No.	Cap. oz.	Spout Length"	Spout Type
<b>PISTOL TYPE</b>			
AC588	4	5	Flexible
AC513	6	5	Flexible
AC597	6	6	Flexible
AC596	6	6	Rigid
AC599	16	6	Flexible
AC598	16	6	Rigid
AC600	33	6	Rigid

Model No.	Cap. oz.	Spout Length"	Spout Type
<b>LEVER TYPE</b>			
AC514	6	6	Flexible
AC515	10	6	Flexible
AC589	13	7	Flexible
AC516	16	7	Flexible
AC592	16	9	Flexible
AC593	16	9	Rigid
AC590	23	8	Flexible
AC594	33	9	Flexible
AC595	33	9	Rigid

## LIQUID MEASURES

- Translucent high density polyethylene construction with graduations
- Comes complete with a polyethylene flexible spout for difficult to reach areas
- Cap on flexible spout and polypropylene lid renders measure spill proof
- Spout length: 7-1/2"
- Spout diameter: 3/4"



Model No.	Cap. Quart
TYB513	1
TYB514	2
TYB515	3
TYB516	5

## FUNNELS

- Translucent high density polyethylene construction
- Wire mesh screen keeps contaminants out
- Comes complete with a polyethylene flexible spout for difficult to reach areas
- Curved funnel ends make the funnel splash and spill proof



Model No.	Diameter"	Capacity Litres
TYB517	8	1.7
TYB518	9-1/2	3



Model No. AC482

## PROFESSIONAL COUPLER

- Hardened spring steel jaws and hardened body withstand high pressures without deformation
- Hexagonal nut allows easy tightening
- Threads: 1/8" NPT
- 4-jaw construction, 6000 PSI
- For hand-operated grease guns only



Model No. AC483

## HEAVY-DUTY COUPLER

- Hardened spring steel jaws and hardened body with double-wall thickness withstand very high pressures without deformation
- Hexagonal nut allows easy tightening
- Threads: 1/8" NPT
- 4-jaw construction, 10000 PSI
- For hand and air operated equipment



Model No. AC484

## 360° SWIVEL HYDRAULIC COUPLER

- Excellent coupler for effective lubrication of difficult and hard-to-reach grease fittings
- Swivels in full 360° circle and locks conveniently at any 45° position
- 45° angle gives easy access to most grease fittings
- Spring-loaded ball-check valve helps retain pressure
- Threads: 1/8" NPT
- 3-jaw construction, 7000 PSI

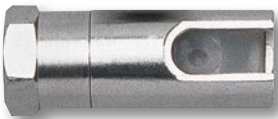

Model No. AC485

## RIGHT-ANGLED HYDRAULIC COUPLER

- Fits all standard grease guns
- Designed for right-angled discharge of grease, very useful for greasing fittings with limited access or in low heights
- Threads: 1/8" NPT

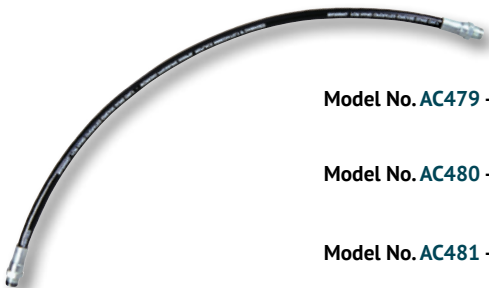

Model No. AC479 - 12"

Model No. AC480 - 18"

Model No. AC481 - 18"

## FLEXIBLE GREASE HOSES

- Standard grease hose is the most popular version of flexible grease hoses
- AC481 hose fitted with heavy-duty spring guard adds safety and convenience in fitting, as well as preventing the hose from bending
- Threads: 1/8" NPT
- W.P. 3500 PSI
- For hand-operated grease guns only

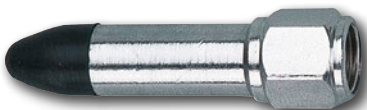

Model No. AC491

## SEAL-OFF DISPENSER

- Used with grease gun extension or hose for lubricating grease plugs
- Threads: 1/8" NPT

## STEEL BEARING PACKER

- For use with grease guns
- The design incorporates a grease nipple at one end which easily adapts to the diameter grease gun coupler
- Greases bearings in cars, boats, trailers, RV's etc. with a minimum inner diameter of 1/2" to a maximum outer diameter of 5" and height from 1/4" to 2"

Model No. AC493



## GREASE GUN HOLDER

- Simple snap action clamp for safe storage of grease guns and suction guns
- Fits all standard grease guns

Model No. AC486



## GREASE INJECTOR NEEDLE

- Lubricates in very tight spaces such as universal joints and sealed bearings
- Equipped with standard grease fitting without ball check and protective plastic holder
- 18-gauge needle thickness
- 1-1/2" long

Model No. AC487



## NEEDLE NOSE ADAPTOR

- Used for dispensing a fine line of grease through the needle nose
- Quick-connect action
- Tip diameter: 0.046" (1.168 mm)
- Needle length: 4"

Model No. AC488



## NEEDLE NOSE DISPENSERS

- Used for dispensing a fine line of grease
- Can be attached directly to steel extensions or flexible hoses
- Threads: 1/8" NPT

Model No. AC489

Model No. AC490

AC489: 15 mm Needle Length, 0.219" (5.56 mm) needle diameter  
 AC490: 38 mm Needle Length, 0.156" (3.96 mm) needle diameter



## EZEE-LUBE KIT

- The Ezee-Lube kit contains a range of quick-connect fittings designed to meet any and every greasing application

Model No. AC492



## EASY-OUT TOOLS

- Handy, dual-purpose tool for removing worn and broken grease fittings, as well as retapping holes for installing new grease fittings

Model No. AC511

Model No. AC512

AC511: 1/4" - 28 tap rethreads  
 AC512: 1/8" - 27 tap rethreads





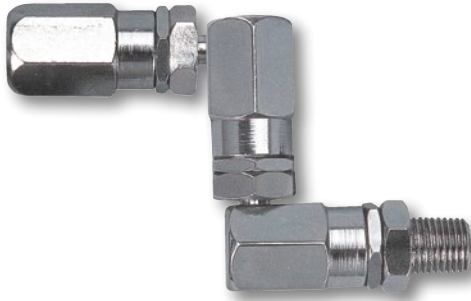

## SWIVELS

- Installed between the delivery hose and grease control valve, swivels permit easy handling of control valves and prevent damage to hose caused by twisting
- 6000 PSI

### THREAD SPECIFICATIONS:

**Model No. AC499**  
1/4" NPT (F) - 1/4" NPT (M)

**Model No. AC500**  
1/4" NPT (F) - 1/8" NPT (M)

## GREASE FITTINGS

- Manufactured to the most stringent quality standards
- QS9000 Approved



AC501



AC504



AC507

### S.A.E.

Model No.	Description
<b>1/4" - 28 S.A.E.-LT PIPE THREADS - SET OF 10</b>	
AC501	Short - Straight
AC502	Short - 45°
AC503	Short - 90°
<b>1/8" - 27 NPT PIPE THREADS - SET OF 10</b>	
AC504	Short - Straight
AC505	Short - 45°
AC506	Short - 90°
<b>DRIVE FITTING - SET OF 10</b>	
AC507	For 3/16" Drill

### METRIC

Model No.	Description
<b>M6 X 1 PIPE THREADS - SET OF 10</b>	
AD202	Straight
AD203	90° Degree
<b>M8 X 1 PIPE THREADS - SET OF 10</b>	
AD204	Straight
AD205	90° Degree
<b>M10 X 1 PIPE THREADS - SET OF 10</b>	
AD206	Straight
AD207	90° Degree

## GREASE FITTING SETS



### SETS

Model No.	Description /Contains
AC509	<b>80 PCS. OF S.A.E. GREASE FITTINGS:</b> 15 Pcs. of 1/4" 28 S.A.E. LT Straight, 10 Pcs. of 1/4" 28 S.A.E. LT 45° Angle, 10 Pcs. of 1/4" 28 S.A.E. LT 90° Angle, 25 Pcs. of 1/8" 27 NPT Straight, 10 Pcs. of 1/8" 27 NPT 45° Angle, 10 Pcs. of 1/8" 27 NPT 90° Angle
AC510	<b>80 PCS. OF METRIC GREASE FITTINGS:</b> 20 Pcs. of M6 x 1 Straight, 10 Pcs. of M6 x 1 90° Angle, 15 Pcs. of M8 x 1 Straight, 10 Pcs. of M8 x 1 90° Angle, 15 Pcs. of M10 x 1 Straight, 10 Pcs. of M10 x 1 90° Angle

# ELECTRICAL

- Extension Cords ..... 72-74
- Electrical Accessories..... 74
- Work Lights ..... 75,77
- Flash Lights..... 76
- Head Lamps.....77
- Booster Cables .....77
- Battery Tester .....77

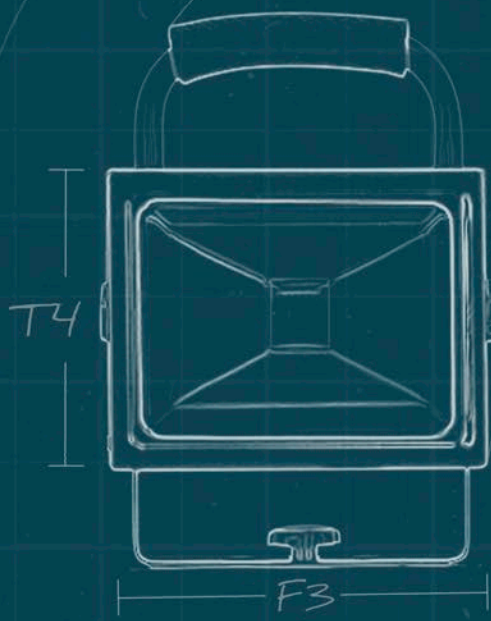

# EXTENSION CORDS

## OUTDOOR VINYL TRIPLE TAP EXTENSION CORDS

- Designed for industrial and contractor use
- Vinyl jacket protects against rough use, chemicals, and moisture
- Vinyl jacket provides added flexibility
- Molded-on and bonded plugs and connectors resist breaking

### 3-CONDUCTOR SJTW, 300 VOLTS GROUNDING

Model No.	Length'	AWG	Amps	Watts	Colour
<b>HEAVY-DUTY</b>					
XC488	25	14/3	15	1875	Red
XC489	50	14/3	15	1875	Red
XC490	100	14/3	13	1625	Red
<b>EXTRA HEAVY-DUTY</b>					
XC491	25	12/3	15	1875	Red
XC492	50	12/3	15	1625	Red
XC493	100	12/3	15	1625	Red



## OUTDOOR VINYL EXTENSION CORDS WITH LIGHT INDICATOR

- Designed for industrial and contractor use
- Vinyl jacket protects against rough use, chemicals, and moisture
- Ultra flexible cord
- Lighted connectors allow you to see when the power is in use
- Molded-on and bonded plugs and connectors resist breaking
- Water resistant and flame retardant

### 3-CONDUCTOR SJTOW, 300 VOLTS GROUNDING, OIL RESISTANT

Model No.	Length'	AWG	Amps	Watts	Colour
<b>EXTRA HEAVY-DUTY</b>					
XC494	25	12/3	15	1875	Yellow
XC495	50	12/3	15	1875	Yellow
XC496	100	12/3	15	1875	Yellow



## OUTDOOR TRIPLE TAP VINYL EXTENSION CORDS WITH LIGHT INDICATOR

- Same great features as outdoor single tap vinyl extension cords but with a lighted triple tap connector

### 3-CONDUCTOR SJTOW, 300 VOLTS GROUNDING, OIL RESISTANT

Model No.	Length'	AWG	Amps	Watts	Colour
<b>EXTRA HEAVY-DUTY</b>					
XC497	25	12/3	15	1875	Yellow
XC498	50	12/3	15	1875	Yellow
XC499	100	12/3	15	1875	Yellow





## INDOOR/OUTDOOR STANDARD DUTY EXTENSION CORDS

- Designed for light industrial, contractor, and home use
- Durable SJTW jacket protects against ultraviolet rays, chemicals and moisture
- Extremely flexible jacket
- Molded-on and bonded plugs and connectors resist breaking

### 3-CONDUCTOR SJTW, 125 VOLTS GROUNDING

Model No.	Length'	AWG	Amps	Watts	Colour
XC630	10	16/3	13	1625	Orange
XC631	15	16/3	13	1625	Orange
XC632	25	16/3	13	1625	Orange
XC633	50	16/3	13	1625	Orange



## OUTDOOR VINYL EXTENSION CORDS

- Designed for industrial and contractor use
- Vinyl jacket protects against rough use, chemicals, and moisture and provides added flexibility
- Molded-on and bonded plugs and connectors resist breaking

### 3-CONDUCTOR SJTW, 300 VOLTS GROUNDING

Model No.	Length'	AWG	Amps	Watts	Colour
<b>HEAVY-DUTY</b>					
XC482	25	14/3	15	1875	Orange
XC483	50	14/3	15	1875	Orange
XC484	100	14/3	13	1625	Orange
<b>EXTRA HEAVY-DUTY</b>					
XC485	25	12/3	15	1875	Yellow
XC486	50	12/3	15	1875	Yellow
XC487	100	12/3	15	1875	Yellow



## ALL WEATHER TPE-RUBBER EXTENSION CORDS WITH LIGHT INDICATOR

- Designed for industrial and contractor use
- All weather jacket provides ultra flexibility and superior performance in extreme climate conditions at temperatures from -50°C to 105°C
- Provides outstanding resistance against rough use, sunlight, chemicals and moisture
- Water resistant and flame retardant
- Lighted connectors allow you to see when the power is in use
- Molded-on and bonded plugs and connectors resist breaking

### 3-CONDUCTOR SJEOW, 300 VOLTS GROUNDING

Model No.	Length'	AWG	Amps	Watts	Colour
<b>HEAVY-DUTY</b>					
XC500	25	14/3	15	1875	Blue/Orange
XC501	50	14/3	15	1875	Blue/Orange
XC502	100	14/3	15	1625	Blue/Orange
<b>EXTRA HEAVY-DUTY</b>					
XC503	25	12/3	15	1875	Blue/Orange
XC504	50	12/3	15	1875	Blue/Orange
XC505	100	12/3	15	1875	Blue/Orange





## WIND-UP EXTENSION CORD

- 4 grounded outlets
- Built-in resettable circuit breaker
- Wind-up the cord by manually rotating the wheel
- Length: 25'
- Gauge (AWG): 16/3
- Amperage: 10 A
- Wattage: 1250 W

Model No. XE671

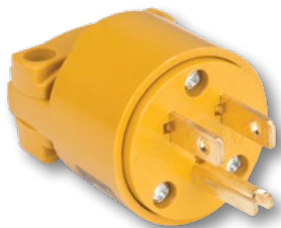

## PVC GROUNDING PLUG

- Amps: 15 A
- Volts: 125 V
- Cord diameter: 0.245" - 0.655"
- Wire gauge: 16/3 to 14/3 cords
- Colour: Yellow
- Moisture and chemical resistant plastic body
- Ideal for indoor and outdoor use
- Nema configuration: 5-15P/5-15R
- Body material: Plastic

Model No. XE672



## PVC GROUNDING CONNECTOR

- Amps: 15 A
- Volts: 125 V
- Cord diameter: 0.245" - 0.655"
- Wire gauge: 16/3 to 14/3 cords
- Colour: Yellow
- Moisture and chemical resistant plastic body
- Ideal for indoor and outdoor use
- Nema configuration: 5-15P/5-15R
- Body material: Plastic

Model No. XE673



## SURGE SUPPRESSOR

- Lighted on/off switch with built-in circuit breaker
- Protects against damage caused by power spikes
- Ideal for multiple electronic devices
- No. of outlets: 6
- Rated Jules: 200
- Max. Amps: 15 A
- Wattage: 1875 W
- Voltage: 125 V

Model No.	No. of USB Ports	Cord Length'
XE670	-	3
XH064	2	6



## WORKSHOP POWER BOX

- Rated Joules: 1050 J
- Outlets: Total of 8 - 5 standard, 3 wide space
- Housing Material: Metal
- Features cord wrap and surge protector to protect your devices from an overload
- Lighted on/off switch
- Keyhole slots on the back of the unit allow the model to be mounted under a desk, on walls or other locations
- Indoor use only
- Cord Length: 6'
- Amps: 15 Amps
- Wattage: 1875 W
- Voltage: 125 V

Model No. XH162

## PORTABLE HALOGEN WORK LIGHTS

- 500-watt halogen work light
- Heat resistant tempered glass face
- Adjustable tilting head
- Colour: Black and yellow
- Halogen bulb included
- Certified for sale in Canada by an accredited certification body

Model No. XC949

**REPLACEMENT BULB**  
Model No. XC951



## PORTABLE LED WORK LIGHTS

- Adjustable tilting head
- Lumens: 2500
- Wattage: 20
- Housing Material: Aluminum
- Certified for sale in Canada by an accredited certification body

Model No. XG816



## TWIN HEAD HALOGEN WORK LIGHTS

- Twin 500-watt halogen lights
- Heat resistant tempered glass face
- Adjustable tripod for desired height
- Extendable tripod legs provide greater stability
- Colour: Black and yellow
- Halogen bulbs included
- Certified for sale in Canada by an accredited certification body

Model No. XC950

**REPLACEMENT BULB**  
Model No. XC951



## TWIN HEAD LED WORK LIGHTS

- Adjustable tripod for desired height
- Extendable tripod legs provide greater stability
- Fixtures can adjust 120°
- Certified for sale in Canada by an accredited certification body
- Lumens: 4800
- Wattage: 40
- Housing Material: Aluminum

Model No. XG817



## AFL300 LED FLASHLIGHT

- Material: Aluminum
- Colour: Black
- High strength aluminum casing
- Shatterproof lens
- Batteries included
- **XE889:** 3 lighting settings: Low 9 LED, Medium 24 LED and High 45 LED



Model No.	Lumens	Run Time Hrs	Batteries Required	Beam Distance	Bulb
<b>XE888</b>	98	3	3 AAA	35 m	35 LED
<b>XE889</b>	31-157	2-3	4 AAA	45 m	45 LED

## AFL100 LED FLASHLIGHT

- Super bright LED bulb
- Polypropylene body resists grease and chemicals
- Shatterproof lens
- Ribbed non-slip barrel
- High visibility yellow colour for easy visibility
- Batteries not included



Model No.	Description	Lumens
<b>XC977</b>	Flashlight, 2 AA-cells	28
<b>XC978</b>	Flashlight, 2 D-cells	35

## AFL200 MINI LED FLASHLIGHT

- Nine ultra bright LED lights
- 25 lumens
- High-strength aluminum casing
- On/Off switch
- Lightweight design
- Rugged impact resistant housing
- Includes wrist strap and three AAA alkaline batteries



Model No. XD079

## CREE® LED PENLIGHT

- Penlight is extremely durable while lightweight to alleviate wrist fatigue
- Aluminum body is corrosion and rust-resistant
- Attaches securely to pockets, belts and briefcases with convenient clip
- Penlight is ideal for various applications such as household work, automobile maintenance and recreational activities
- Lumens: 80
- Run Time Hrs. (High): 4
- Beam Distance (High): 50 m
- Batteries included: 2 x AAA



Model No. XH073

## AFL400 LED RECHARGEABLE SPOTLIGHT

- Single LED spotlight has an extremely bright beam featuring long distance visibility
- Spotlight features an additional side-light that can be used as a free-standing lantern
- Certified for sale in Canada by an accredited certification body
- Spotlight is ideal for various applications, such as household work, facility maintenance, general labor and recreational activities
- Side-light Lumens: 180
- Lumens (High): 516
- Run Time Hrs. (High): 6
- Material: Plastic
- Beam Distance (High): 500 m



Model No. XH109

## ANALOG BATTERY TESTER

- Compatible with the majority of standard household batteries
- Analog scale displays the capacity of the battery instantly (Replace, Low, Good)
- No batteries required to operate
- Moveable arm can fit multiple battery sizes
- Compact size and easy to use
- Battery Type(s): AAA, AA, C, D, 9V

Model No. XF613



## BOOSTER CABLES

- Clamp design fits on both top-post and side-post batteries
- Surge suppressor on 2, 4, and 6 gauge cables protect a vehicles computer system from power surges during boosting
- Cable remains flexible in temperatures as low as -40°C
- Tangle-free

Model No.	Wire Gauge	Amps	Length'
XE494	8	150	10
XE495	6	400	16
XE496	4	400	20
XE497	2	400	20



## INDUSTRIAL WORK LIGHT

- Light Capacity (watts): 75
- Cord Length': 25
- Rugged impact resistant housing
- On/Off switch handle
- Certified for sale in Canada by an accredited certification body
- Lightweight design
- Grounded cord
- Includes: Hanging hook and electric outlet

Model No. XC660



## LED HEADLAMP

- 7 ultra bright LED lights
- 3 brightness levels - 7 LEDs, 3 LEDs, 1 LED
- Water resistant
- Lightweight design
- Tilting head and adjustable head strap
- Batteries Required: 3 AAA

Model No. XC658



Hard hat not included

## CREE® LED HEADLAMP

- Lamp Type: Cree® LED
- Lumens: 30-120
- Run Time Hrs.: 6-20
- Material: Aluminum and Plastic
- Beam Distance: 120 m
- Batteries Included: 3 AAA
- 3 settings: High, Low and Strobe
- Head angle is adjustable
- Adjustable in/out zoom
- Water resistant

Model No. XE887







# FACILITY MAINTENANCE

Sprayers .....	79
Bottles .....	79
Vacuums .....	80-81
Tarps .....	82-83
Paint Brushes .....	84
Spatulas & Masking Tape .....	85
Hand Pads .....	85
Shovels .....	86-88
Spreaders .....	88

## COLD WATER PISTOL GRIP NOZZLE

- Vinyl molded comfort grip
- For use with water temp. under 26°C (80°F)
- Continuous-spray stainless steel clip
- Threaded for attaching accessories
- Non-Insulated
- Max. Pressure: 100 psi
- Rear-Trigger
- Body material: Zinc & Vinyl
- Fitting material: POM with aluminum center

Model No. NM814



## COLD/WARM WATER PISTOL GRIP NOZZLE

- Heavy-duty construction and components
- For use with water temp. up to 49°C (120°F)
- Continuous-spray stainless steel clip
- Threaded for attaching accessories
- Insulated
- Max. Pressure: 100 psi
- Rear-Trigger
- Body material: Zinc & TPR
- Fitting material: POM with Aluminum Center

Model No. NM816



## COLD/WARM WATER PISTOL GRIP NOZZLE

- Ergonomic grip for longer usage
- For use with water temps up to 49°C (120°F)
- Continuous-spray stainless steel clip
- Screen filter prevents clogs
- Insulated
- Max. Pressure: 100 psi
- Rear-Trigger
- Body material: Zinc & ABS
- Fitting material: POM with Aluminum Center

Model No. NM815



## HOT WATER PISTOL GRIP NOZZLE

- Heavy-duty construction and components
- Poly-clad metal body for use with hot and cold water
- For use with water temp. up to 71°C (160°F)
- Continuous-spray stainless steel clip
- Threaded for attaching accessories
- Insulated
- Max. Pressure: 100 psi
- Rear-Trigger
- Body material: Zinc & TPR
- Fitting material: Aluminum

Model No. NM817



NI408

NI412

NG655

## PLASTIC BOTTLES

- Blow-molded from high-density polyethylene
- Available in 3 sizes: 16 oz., 24 oz. and 32 oz.

Model No.	Description	Dimensions		
		H"	x	D"
NI408	16 oz. Cylindrical Without Graduations	7-7/8	x	2-1/2
NG655	24 oz. Round With Graduations	8	x	3-1/8
NI424	32 oz. Round With Graduations	9-7/8	x	3-1/8
NI412	24 oz. Round With WHMIS Label & Graduations	8	x	3-1/8

## TRIGGER SPRAYERS

- All sprayers adjustable to provide fine mist to a steady stream
- Dip tubes available in two lengths and come equipped with filter screen



## MULTI PURPOSE SPRAYER 8" DIP TUBE RED/WHITE

Model No. NJ166



## LARGE MULTI-PURPOSE SPRAYER 9" DIP TUBE BLUE/WHITE

Model No. NJ167

# INDUSTRIAL WET/DRY VACUUMS

## INDUSTRIAL WET/DRY STAINLESS STEEL VACS

- 8 US gallon stainless steel tank
- 5.5 peak HP motor
- 85 CFM air flow
- 72" Sealed pressure
- Swivel casters provide easy movement in any direction
- Positive lock on hose eliminates unexpected disconnections
- 18' power cord
- **1-1/4" Accessories include:** Flexible hose, extension wands, crevice tool, utility nozzle, floor brush, cartridge filter and dust bag

Model No. JC525



## INDUSTRIAL WET/DRY STAINLESS STEEL VACS

- 16 US gallon stainless steel tank
- 6.5 peak HP motor
- 100 CFM air flow
- 80" Sealed pressure
- Heavy-duty rear wheels with swivel front casters provide easy movement
- Removable steel handle
- Positive lock on hose eliminates unexpected disconnections
- Large accessory storage box attached
- 20' Power cord
- **2-1/2" Accessories include:** Flexible hose, extension wands, crevice tool, utility nozzle, floor brush, cartridge filter and dust bag

Model No. JC528



## ACCESSORIES & REPLACEMENT PARTS



Model No.	Description	Fits US Gallon Size
JC531	Cartridge Filter	8 - 16
JC689	HEPA Cartridge Filter	8 - 16
JC588	Dust Collector Bag 3/Pk	8
JC591	Dust Collector Bag 3/Pk	16
JC534	Extension Wands	8
JC535	Utility Brush	8
JC536	6' Flexible Hose	8
JC537	Floor Brush	8
JC538	Crevice Tool	8
JC539	Caster Dolly	8
JC540	Casters	8

Model No.	Description	Fits US Gallon Size
JC541	Extension Wands	16
JC542	Utility Brush	16
JC834	7' Flexible Hose for Ribbed Tank	16
JC544	Floor Brush	16
JC545	Crevice Tool	16
JC546	Casters	16
JC547	Rear Wheels	16
JC587	Accessory Holder	8
JD108	Caster Brackets for Ribbed Tank	16
JC675	Replacement Cartridge Filter Cover	8

## INDUSTRIAL WET/DRY POLY VACUUM

- Tank Capacity: 8 US Gal. (30.28 Litres)
- Peak HP: 6
- Motor Stage: 1-Stage
- Air Flow: 95 CFM
- Swivel casters provide easy movement in any direction
- Positive lock on hose eliminates unexpected disconnects
- 16' power cord
- **1-7/8" Accessories include:** Flexible hose, extension wands, utility nozzle, crevice nozzle, floor brush, cartridge filter and dust bag

Model No. SDN116



## INDUSTRIAL WET/DRY POLY VACUUM

- Tank Capacity: 16 US Gal. (60.5 Litres)
- Peak HP: 6
- Motor Stage: 1-Stage
- Air Flow: 100 CFM
- Swivel casters provide easy movement in any direction
- Positive lock on hose eliminates unexpected disconnects
- 16' power cord
- **2-1/2" accessories include:** Flexible hose, extension wands, utility nozzle, crevice nozzle, floor brush, cartridge filter and dust bag

Model No. SDN119



## ACCESSORIES & REPLACEMENT PARTS



Model No.	Description	Fits US Gallon Size
JC531	Cartridge Filter	8 - 16
JC689	Hepa Cartridge Filter	8 - 16
JG724	Dust Collector Bag 3/Pk	8
JC591	Dust Collector Bag 3/Pk	16
JC534	Extension Wand	8
JC541	Extension Wand	16
JC535	Utility Brush	8

Model No.	Description	Fits US Gallon Size
JC542	Utility Brush	16
JC536	6' Flexible Hose	8
JG731	6' Flexible Hose	16
JC537	Floor Brush	8
JC544	Floor Brush	16
JC538	Crevice Tool	8
JC545	Crevice Tool	16



## HEAVY DUTY CAMOUFLAGE TARPAULINS

- 10 x 10 weave density
- Water-resistant coating
- Reinforced polypropylene rope sewn in welded hems
- 150 micrometers (6 mil) thick
- Increased UV-resistance for long life
- Finished sizes may vary due to hem allowance



Model No.	Dimensions W' x L'
J1319	6 x 8
J1320	8 x 10
J1321	10 x 20
J1322	12 x 16
J1323	16 x 20
J1324	18 x 24
J1325	20 x 30
J1326	30 x 40

## INDUSTRIAL DUTY BLACK TARPAULINS

- 14 x 14 weave density
- Water-resistant coating
- Reinforced polypropylene rope sewn in welded hems
- 200 micrometers (8 mil) thick
- Increased UV-resistance for long life
- Finished sizes may vary due to hem allowance



Model No.	Dimensions W' x L'
J1327	6 x 8
J1328	8 x 10
J1329	10 x 20
J1330	12 x 16
J1331	16 x 20
J1332	18 x 24
J1333	20 x 30
J1334	24 x 30
J1335	30 x 40
J1336	30 x 50
J1337	40 x 50
J1338	40 x 60

## CLEAR TARPAULINS

- Polyethylene tarpaulin with reinforced nylon gridding
- Water and mildew resistant coating
- Heavy-duty rust resistant grommets
- 3 x 3 weave density
- 200 micrometers (8-mil) thick
- Finished sizes may vary due to hem allowance



Model No.	Dimensions W' x L'
JD414	8 x 10
JD415	10 x 12
JD416	16 x 20
JD417	20 x 30
JD418	30 x 40
JD419	40 x 60

## POLYETHYLENE TARPAULINS



- Reinforced polypropylene rope sewn in welded hems
- Increased UV resistance for long life
- Water resistant coating
- Finished sizes may vary due to hem allowance

### STANDARD-DUTY BLUE

- Heavy-duty rust-resistant grommets every 36"
- 8 x 8 weave density
- 100 micrometres (4-mil) thick

### HEAVY-DUTY WHITE

- Heavy-duty rust-resistant grommets every 36"
- 10 x 10 weave density
- 150 micrometres (6-mil) thick
- Four corner patches

### INDUSTRIAL GREEN/SILVER

- Heavy-duty rust-resistant grommets every 20"
- 14 x 14 high density weave
- 225 micrometres (9-mil) thick
- 9" x 9" triple-layered on four corners
- Silver side provides heat and UV light diversion

### SUPER HEAVY-DUTY SILVER

- Heavy-duty rust-resistant grommets every 30"
- 16 x 16 high density weave
- 300 micrometres (12-mil) thick
- 9" x 9" triple-layered on four corners

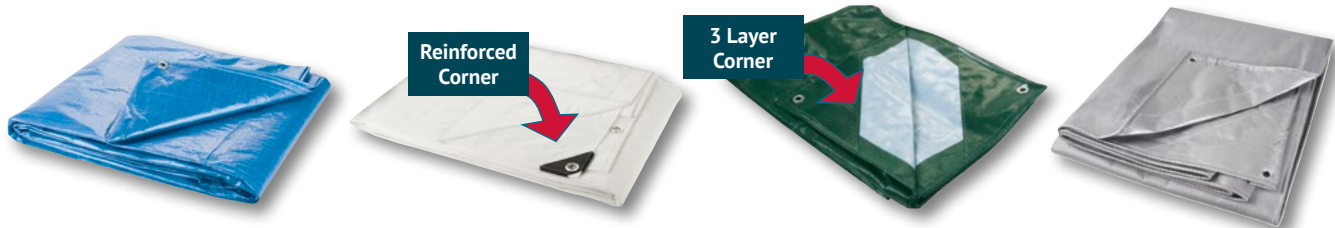

	STANDARD BLUE	HEAVY-DUTY WHITE	INDUSTRIAL GREEN/SILVER	SUPER HEAVY-DUTY SILVER
Dimensions W' x L'	Model No.	Model No.	Model No.	Model No.
5 x 7	NI768	-	-	-
6 x 8	NI769	NI780	JB567	-
8 x 10	NI770	NI781	JB568	JC626
10 x 12	NI771	NI782	JB569	JC627
10 x 20	NI772	-	-	-
12 x 16	NI773	NI783	JB570	-
16 x 20	NI774	NI784	JB571	JC628
18 x 24	NI775	JC512	-	JC629
20 x 30	NI776	JC513	JB572	JC630
24 x 30	NI777	NI785	-	JC631
30 x 40	NI778	JC514	JC516	JC632
30 x 50	JC510	JC515	JC517	JC633
30 x 60	-	-	-	JC634
40 x 50	JC511	JC625	JC518	-
40 x 60	NI779	JB508	JB573	JC635

## INSULATED TARPAULINS

- Lightweight and flexible, moisture resistant insulated tarpaulin
- Manufactured with 3/16" closed cell polyethylene foam insulation
- R-value is maintained in damp cold conditions
- Durable, water resistant polyethylene shell
- Heavy-duty rust resistant grommets every 2'
- R value: 1.0
- Dimensions: 12' W x 20' L

Model No. JD420

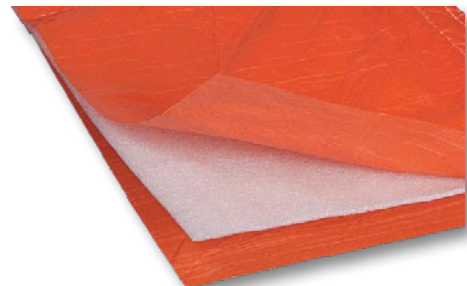



KP307



KP308

## AP100 SERIES PAINT BRUSHES

- 100% black polyester bristles
- Solid plastic handle
- Tin-plated ferrule
- Well-suited for latex-based paints

Model No.	Width"
KP307	1
KP308	2
KP765	3
KP766	4



KP306



KP297

## AP200 SERIES PAINT BRUSHES

- Pure white bristles
- Solid plain wood handle
- Tin-plated ferrule
- Well-suited for oil-based paints

Model No.	Width"
KP306	0.5
KP297	1
KP298	2
KP299	3



KP300



KP301

## AP300 SERIES PAINT BRUSHES

- Natural bristles
- Solid plastic handle
- Tin-plated ferrule
- Well-suited for oil-based paints

Model No.	Width"
KP300	1
KP301	2
KP302	3
KP303	4



KP304

## AP400 SERIES PAINT BRUSHES

- Foam brush
- Solid wood handle
- Disposable
- Well-suited for applying urethane or for touch-up jobs

Model No.	Description	Width"
KP335	Premium	1
KP304	Standard	1



KP726

## MULTI-USE PAINT ROLLER SLEEVE

- Designed for smooth surfaces
- Length: 230 mm (9")
- Sleeve Material: Polyester Fibre
- Core Material: PP (Polypropylene)
- Core Diameter: 1-1/2"
- Application Type: Oil and Latex Paints

Model No.	NAP" (mm)	Surface
KP726	1/4 (6)	Smooth
KP727	3/8 (9.525)	Semi-Smooth

## PAINTERS MASKING TAPE

- High quality painting tape adheres to multiple surfaces
- Reliable adhesion resists paint bleed-through
- Removes cleanly in one piece
- Length: 180' (55 m)
- Colour: Green



Model No.	Width
PF690	1" (25 mm)
PF691	2" (50 mm)

## GENERAL PURPOSE MASKING TAPE

- Designed for all general purpose masking projects offering a good adhesion to a wide variety of surfaces.
- Resists lifting or curling
- Removes easily and cleanly
- Length: 180' (55 m)
- Colour: Beige



Model No.	Width
PF886	3/4" (19 mm)
PF887	1" (25 mm)
PF888	2" (50 mm)

## SEALING SPATULAS

- Ideal for spreading or removing sealant and adhesives
- Manufactured with fibreglass reinforced plastic
- Exceptional durability
- Flexible tips

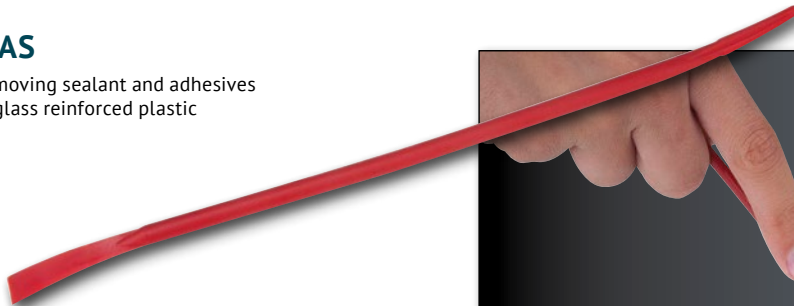

Model No.	Length"	Large Tip Width"	Small Tip Width"	Qty /Pkg
TLV164	7-1/4	1/4	1/8	5
TLV568	7-1/4	1/2	3/8	4

## HAND PADS

- Non-woven, synthetic fibres, bonded together with specially formulated resins and impregnated throughout the web with mineral grain creating an open, three dimensional structure
- Designed for light-duty cleaning, polishing, scuffing, finishing and for heavy-duty paint, rust and corrosion removal
- Can be used for dry scuffing and finishing or may be used with water or chemical solvents
- Flexible and strong
- 6" x 9"

Model No.	Description	Finish	Case Qty
NU022	Tan Heavy-Duty	Coarse	10
NU023	Green Industrial	Scouring	20
NU024	Maroon General Purpose	Medium	20
NU025	Grey Ultra Fine	Ultra-Fine	20
NU026	White Non-Abrasive	Non-Abrasive	20

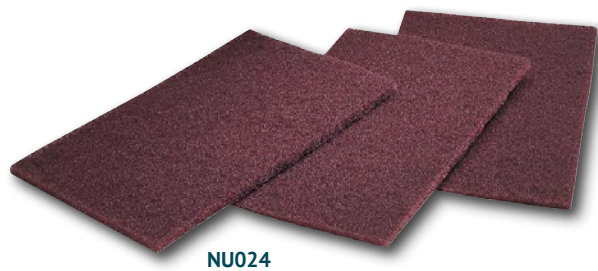



# STANDARD-DUTY SHOVELS

- 14-gauge tempered steel blade
- Durable fibreglass handle with rubber grip
- Forward-turned step for extra strength
- Ergonomic grip



NJ093

TLZ465

NJ094

NJ095

NJ096

NJ098

NJ099

## ROUND POINT SHOVELS

Model No.	Handle Type	Blade Size W" x H"	O.A. Length"
NJ093	D-Grip	8-1/2 x 11	42
TLZ465	Straight	8-1/2 x 11	56

## SQUARE SHOVELS

Model No.	Handle Type	Blade Size W" x H"	O.A. Length"
NJ094	D-Grip	8-1/2 x 11-1/2	42
NJ095	Straight	8-1/2 x 11-1/2	56

## DRAIN SPADE

Model No.	Handle Type	Blade Size W" x H"	O.A. Length"
NJ096	D-Grip	6 x 16	45

## WOOD HANDLE SHOVELS

- Heavy-duty, 12 gauge tempered carbon steel blade
- Durable, ergonomic hard wood handle
- Forward turned step for extra strength

Model No.	Blade Style	Blade Size W" x H"	O.A. Length"
NJ098	Square Point	9-1/4 x 11-1/2	60
NJ099	Round Point	8-1/2 x 11-1/2	60

# HEAVY-DUTY SHOVELS

- Heavy-duty, 12-gauge tempered carbon steel blade
- Durable fibreglass handle
- Forward-turned step for extra strength
- Ergonomic grip



## ROUND POINT SHOVELS

Model No.	Handle	Blade Size W" x H"	O.A. Length"
TLZ466	D-Grip	9 x 11	41
TLZ467	Straight	9 x 11	56-1/2

## SQUARE SHOVELS

Model No.	Handle	Blade Size W" x H"	O.A. Length"
TLZ468	D-Grip	9 x 11	41
TLZ469	Straight	9 x 11	56-1/2

## DRAIN SPADE

Model No.	Handle	Blade Size W" x H"	O.A. Length"
TLZ470	D-Grip	6 x 14	45-1/2

## BOW RAKES

All-welded curved steel tines

Model No.	Number of Tines	Handle	Blade Size W" x H"	O.A. Length"
TLZ471	15	Straight	15 x 6	64

## GARDEN SPADE

Model No.	Handle	Blade Size W" x H"	O.A. Length"
NJ143	D-Grip	7-1/2 x 12	42

**FACILITY MAINTENANCE**

# SPREADERS & SHOVELS

## SNOW PUSHERS

- Poly snow pusher with steel wear strip
- Powder-coated steel handle for added strength
- Ergonomic poly D-grip

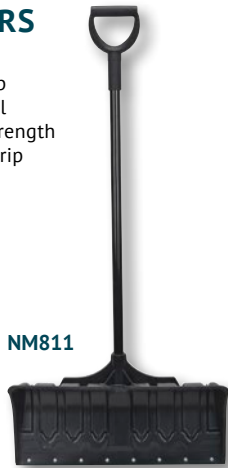

NM811

Model No.	Blade Size"	Overall Length"
NM811	24-1/2 x 10-3/4	51-3/8
NM812	21-1/4 x 9-1/4	50-3/4

## POLY SNOW SHOVELS

- Powder-coated steel handle for added strength
- Ergonomic poly D-grip handle
- **NM809** includes a steel wear strip



NM809

Model No.	Blade Size"	Overall Length"
NM809	19-3/4 x 13-1/8	51
NM810	19-3/4 x 13	51

## SQUARE POINT SCOOP SHOVEL

- Blade Material: Aluminium
- Handle Material: Wood
- Handle Type: Straight
- Overall Length: 63-1/2"
- Weight: 4.16 lbs.
- Blade Size: 14-1/4" x 18"

Model No. TYX063



FACILITY MAINTENANCE

## POLY NOZZLE HAND SPRAYERS

- Ideal for many jobs in the garden, home, farm, or commercially
- Chemical resistant poly bottle
- Adjustable poly nozzle for fine mist or straight stream
- Equipped with Buna-N seals
- Capacity: 48 oz.
- Suitable for water soluble liquids only
- Maximum spraying distance: 13'

Model No. NJ163

NJ165



NJ163



NJ164



## BRASS NOZZLE HAND SPRAYERS

- Ideal for many jobs in the garden, home, farm, or commercially
- Chemical resistant poly bottle
- Adjustable brass nozzle for fine mist or straight stream
- Equipped with Viton® seals
- Capacity: 48 oz.
- Suitable for water soluble liquids only
- Maximum spraying distance: 11'

Model No. NJ164

## COMMERCIAL GRADE SPRAYERS

- Chemical resistant poly tank
- Adjustable poly nozzle for fine mist or straight stream
- Critical seals and O-rings made of Viton®
- Built-in pressure release valve for added safety
- Telescopic wand extends for 12" to 24"
- Capacity: 2.2 gallons
- Suitable for water soluble liquids only
- Maximum spraying distance: 11'

Model No. NJ165

## BROADCAST SPREADER

- Steel tube frame construction with chrome plated hardware
- Heavy-duty nylon gear box increases product life span
- Setting control on handle for precise adjustments
- Capacity 100 lbs.
- 12" x 4" pneumatic tires
- Coverage: 16 000 sq.ft.
- Comes with rain cover and screen
- Assembly required

Model No.	Blade Size"	O.A. Length"
NJ142	11 x 8-1/2	60



# PACKAGING & SHIPPING

Staple Guns .....	90
Glue Guns .....	90
Tape .....	91
Tape Dispensers .....	91
Packing List Envelopes .....	91
Utility Knives.....	92-93
Packaging Accessories.....	93
Cable Ties .....	94

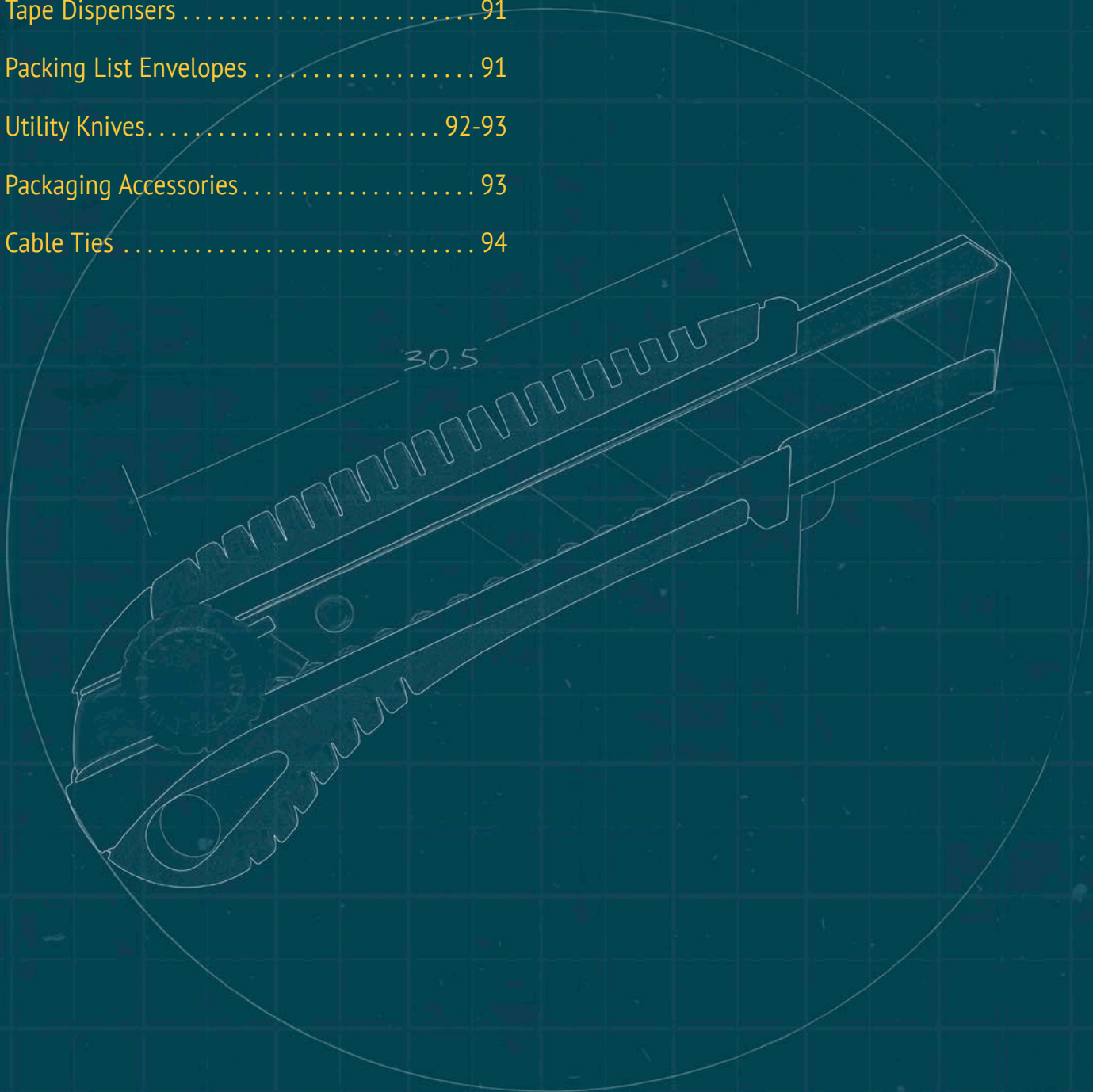



# STAPLE & GLUE GUNS



## HEAVY-DUTY STAPLE GUN

- All-steel construction, with rubberized handle for superior grip
- Easy squeeze, double leverage handle reduces operators fatigue
- Hand-contoured handle features molded plastic handle stop
- Bottom loading, with jam proof mechanism
- Adjustable driving force facilitates use
- Accepts staples in 3 lengths: 5/16", 3/8" and 1/2", with a crown width of 3/8"

Model No. PE337



## HEAVY-DUTY HAMMER TACKER

- All-steel construction, with rubberized handle for superior grip
- Precision locked rear loading, with jam proof mechanism
- Retractable striking edge
- Chrome plated finish
- Accepts staples in 3 lengths: 5/16", 3/8" and 1/2", with a crown width of 3/8"

Model No. PE338



## STAPLES

Model No.	Length"	Crown"	Qty /Box
ON919	5/16	3/8	500
ON920	3/8	3/8	500
ON921	1/2	3/8	500

PACKAGING & SHIPPING



PE339

## GLUE GUNS

- Accepts 7/16" diameter regular glue sticks
- Trigger design for better grip control
- Features precise, even adhesive distribution
- 120 volt/80 watt heater
- Comes with metal wire stand

Model No.	Description	Heater
PE339	Light-Duty	120 Volt (80 Watt)
PE340	Heavy-Duty	120 Volt (100 Watt)



## GLUE STICKS

Model No.	Appearance	Viscosity Centipoise	Melting Point		Typical Applications	Dim."	Qty /Case
			°C	°F			
PE341	Clear	11000-13000	77-82	170-180	High Strength, High Temp, For Non Porous Materials	7/16 x 4	2000
PE342	Clear	11000-13000	77-82	170-180	High Strength, High Temp, For Non Porous Materials	7/16 x 10	803
PE343	Amber	5000	95	203	For Porous Materials	7/16 x 15	536
PE541	Clear	9400	80	176	All temp. For Porous & Non Porous Materials	7/16 x 10	803

## TAPE DISPENSERS

- Industrial quality tape guns constructed of steel and high impact plastic frame
- Adjustable brake lets you choose the desired release tension

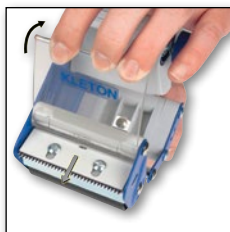

PF713

PE321

# KLETON

Model No.	Description	Blade
PE321	2" Standard-Duty Plastic	Retractable
PE322	2" Heavy-Duty Steel	Retractable
PE323	3" Heavy-Duty Steel	Retractable
PF712	2" Standard-Duty Plastic	Non-retractable
PF713	2" Heavy-Duty Steel	Non-retractable
PF714	3" Heavy-Duty Steel	Non-retractable

## BOX SEALING TAPE

- Quality acrylic adhesive tape provides consistent performance
- Designed to resist center seam splitting
- Fits on most industrial tape guns
- Elongation at break: 130%
- Colour: Clear



# KLETON

Model No.	Dimensions	Thickness	
		Microns	Mils
PF231	2" x 216' (48 mm x 66 m)	40	1.6
PF232	2" x 328' (48 mm x 100 m)	40	1.6
PF233	2" x 328' (48 mm x 100 m)	50	2.0
PF234	3" x 216' (72 mm x 66 m)	40	1.6
PF235	2" x 432' (48 mm x 132 m)	40	1.6

## PACKING LIST ENVELOPES

- Ideal for packing slips, invoices, warranties, instructions, etc.
- Self-adhesive envelopes are fast and convenient to use
- 1000/case
- Back loading



PF787

# KLETON

Model No.	Description	Inside Dimensions"	Outside Dimensions"
PF878	Packing List Enclosed/Bilingual	4 x 5	4-1/2 x 5-1/2
PF879	Blank	4 x 5	4-1/2 x 5-1/2
PF880	Packing List Enclosed	4 x 5	4-1/2 x 5-1/2
PF881	Blank	6-1/2 x 5	7 x 5-1/2
PF882	Packing List Enclosed/Bilingual	6-1/2 x 5	7 x 5-1/2
PF883	Blank	9-1/2 x 5	10 x 5-1/2

## HEAVY-DUTY UTILITY KNIFE ATK100

- Auto-reload blade change
- Auto-lock blade
- Rubber handle insert for superior grip
- Snap-off blades
- Attached blade snapper
- Includes 4 heavy-duty carbon steel blades
- Uses 18 mm blade

**Model No. PE812**



## PROFESSIONAL UTILITY KNIFE ATK300

- Auto-lock blade
- Snap-off blades
- Attached blade snapper
- Uses 18 mm blade

**Model No. PE814**



## PROFESSIONAL UTILITY KNIFE ATK400

- Blade screw lock
- Snap-off blades
- Comes with blade snapper
- Uses 18 mm blade

**Model No. PE813**



## STAINLESS STEEL UTILITY KNIFE ATK500

- Auto-lock blade
- Snap-off blades
- Attached blade snapper
- Built-in belt clip
- Uses 9 mm blade

**Model No. PE815**



## STANDARD-DUTY UTILITY KNIFE ATK600

- Snap-off blades
- Attached blade snapper
- Uses 9 mm blade

**Model No. PE345**



## STANDARD-DUTY UTILITY KNIFE ATK700

- Auto-lock blade
- Durable ABS plastic body
- Snap-off blades
- Attached blade snapper
- Lightweight design
- Uses 18 mm blade

**Model No. PE549**



## HEAVY-DUTY UTILITY KNIFE ATK800

- Blade screw lock
- Snap-off blades
- Ergonomic handle for superior grip
- Uses 25 mm blade

Model No. PF710



## HEAVY-DUTY UTILITY KNIFE ATK900

- Ergonomic handle for superior grip
- Snap-off blades
- Blade Size: 18 mm
- Blade Material: Carbon Steel
- Blade Length: 139 mm
- Blade Thickness: 0.5 mm
- Locking Mechanism: Screw

Model No. PF711



## SELF-RETRACTING UTILITY KNIFE ATK1000

- Self-retracting blade for heightened safety
- Durable ABS plastic body
- Lightweight design
- Durability: Utility
- Blade Size: 18 mm
- Blade Material: Carbon Steel
- Blade Thickness: 0.5 mm

Model No. PF708

REPLACEMENT BLADES:  
Model No. PF709



## REPLACEMENT UTILITY KNIFE BLADES

Model No.	Blade Size	Thickness	Qty/Pack
PE407	9 mm	0.4 mm	10
PF205	18 mm	0.5 mm	10
PE410	25 mm	0.7 mm	10

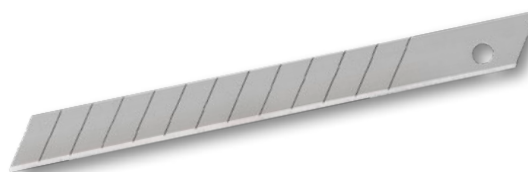

## STRETCH WRAP DISPENSERS

- For a smooth, tight application of stretch wrap
- Needle bearings at the top and bottom of the unit increase tension control
- Tension control knob on top ensures a tight, smooth wrap
- Tension knob also provides a second hand grip for added stability
- Top plate is constructed of cast aluminum for added durability
- Adjusts to hold rolls from 11" to 18" wide

Model No. PE354

KLETON



## BAG SEALERS

- Heavy-duty bag sealer with tape cutter
- Easy to use: just twist bag shut and move through slot

Model No. PE356

REPLACEMENT BLADES:  
Model No. PE383

KLETON





# CABLE TIES & RUBBER TIE DOWNS

## CABLE TIES

- Manufactured from Dupont™ Zytel® 101F and Ascend™ Vydyne® 21SPF
- Ideal use in temperatures ranging from -20° C to 80° C
- **PF396** has the added benefit of weather resistance

Model No.	Style	Length"	Bundle Dia. Min." - Max."	Tensile Strength lbs.	Qty /Bag
PF385	Natural	4	1/16 - 7/8	18	1000
PF386	Black	4	1/16 - 7/8	18	1000
PF387	Natural	6	1/16 - 1-1/4	40	1000
PF388	Black	6	1/16 - 1-1/4	40	1000
PF389	Natural	8	1/16 - 1-3/4	50	1000
PF390	Black	8	1/16 - 1-3/4	50	1000
PF391	Natural	11	1/16 - 3	50	1000
PF392	Black	11	1/16 - 3	50	1000
PF393	Natural	15-1/2	1/16 - 4	120	100
PF394	Black	15-1/2	1/16 - 4	120	100
PF395	Natural	24	3/16 - 7	175	100
PF396	Black	24	3/16 - 7	175	100

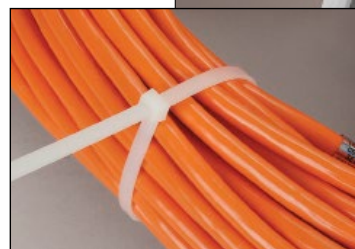
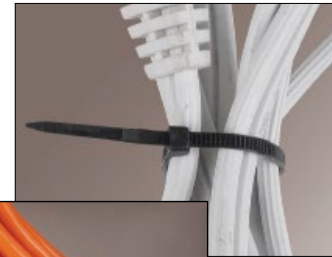

## CABLE TIE SETS

Same great features as the Aurora cable ties, but with the added convenience of a set with mixed sizes.

### Model No. PF397

**SET INCLUDES:**  
 400 x PF387  
 400 x PF389  
 200 x PF391

### Model No. PF398

**SET INCLUDES:**  
 50 x PF393  
 50 x PF395

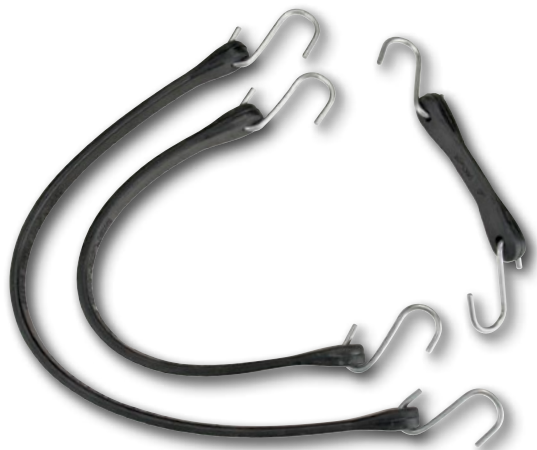

## RUBBER TIE DOWNS

- Material: EPDM gives the ability to resist degradation resulting from weathering agents like UV rays and ozone making it perfect weather resistant rubber
- Retains its rebound qualities
- Rubber Tie Downs Straps resist cracking and rotting
- Durable Zinc plated steel "S" hooks

Model No.	Size"	Max. Safe Stretch"
PE366	5	7.5
PE367	9	13.5
PE368	15	22.5
PE369	21	31.5
PE370	31	46.5
PE371	41	61.5

## RUBBER TIE DOWN SETS

Same great features as KLETON rubber tie downs however in the convenience of sets

### 10-PC. TIE DOWN SET

**SET INCLUDES:**

- 4 - 21" Tie Downs (PE369)
- 2 - 31" Tie Downs (PE370)
- 4 - 41" Tie Downs (PE371)

Model No. PF090

### 16-PC. TIE DOWN SET

**SET INCLUDES:**

- 2 - 9" Tie Downs (PE367)
- 2 - 15" Tie Downs (PE368)
- 4 - 21" Tie Downs (PE369)
- 4 - 31" Tie Downs (PE370)
- 4 - 41" Tie Downs (PE371)

Model No. PF091

### 20-PC. TIE DOWN SET

**SET INCLUDES:**

- 10 - 21" Tie Downs (PE369)
- 10 - 41" Tie Downs (PE371)

Model No. PF092



# WELDING

Welding Wire & Cable Connectors .....	96
Soapstones & Welding Starter Kits.....	97
Electrode Holders & Ground Clamps .....	98
Gauges & Flint Lighters .....	99
Tip Accessories .....	99
Scratch Brushes .....	100
Cable Protectors & Holders .....	100
Arc Gouging Torch & Electrodes .....	101
Cutting Tips.....	102-103

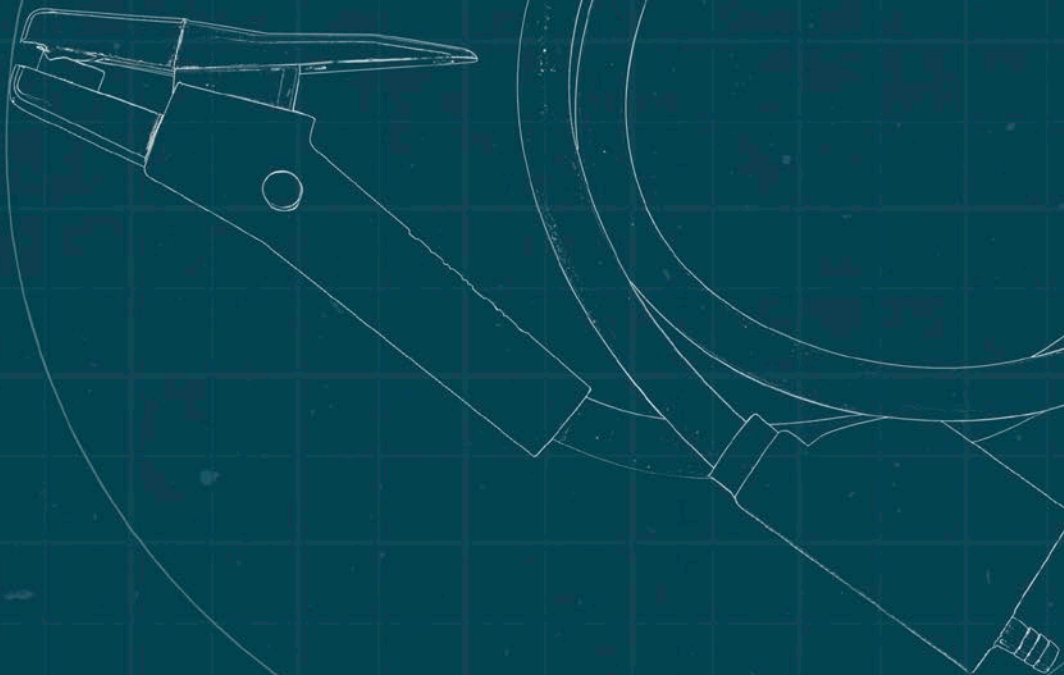

## ER70S6 CARBON STEEL WELDING WIRE

- Highest combination of manganese and silicone deoxidizers
- Permits high current welding with CO<sub>2</sub> gas shielding
- Can also be applied with ArCO<sub>2</sub>
- Excellent wetting
- Good for out-of-position welding using short circuiting transfer
- Layer/level wound wire
- Certified by CWB to CSA class W48 for ER49S-6
- Certified by AWS to class A5.18 for ER70S6

Model No.	Diameter	Spool Weight	Spools Per Master Box
NT549	0.023" (0.6 mm)	2 lbs. (0.9 kg)	18
NT550	0.030" (0.8 mm)	2 lbs. (0.9 kg)	18
NT551	0.035" (0.9 mm)	2 lbs. (0.9 kg)	18
NT552	0.045" (1.14 mm)	2 lbs. (0.9 kg)	18
NT553	0.023" (0.6 mm)	11 lbs. (5 kg)	4
NT554	0.030" (0.8 mm)	11 lbs. (5 kg)	4
NT555	0.035" (0.9 mm)	11 lbs. (5 kg)	4
NT556	0.023" (0.6 mm)	33 lbs. (15 kg)	1
NT557	0.030" (0.8 mm)	33 lbs. (15 kg)	1
NT560	0.035" (0.9 mm)	44 lbs. (20 kg)	1
NT561	0.045" (1.14 mm)	44 lbs. (20 kg)	1



Model No.	Diameter	Drum Weight	Qty Per Pallet
TTU049	0.035" (0.9 mm)	550 lbs. (250 kg)	4
TTU519	0.045" (1.14 mm)	550 lbs. (250 kg)	4

## CAM ACTION CABLE CONNECTORS

- One model fits cable sizes 4 through 4/0
- Manufactured from heavy wall precision machined brass alloy
- Cable is held securely by large dome screw
- Brass body assembly slides easily into unique heavy-duty neoprene insulator with no external screws to avoid shock hazards
- Cam locking connectors are compatible with most common brands

Model No.	Description
NT664	Male/Female Connector Set
NT649	Male Half With Insulator
NT650	Female Half With Insulator





## SOAPSTONES

- White soapstone
- Sold in box quantity of 144

Model No.	Description
NT225	Flat Soapstone
NT226	Round Soapstone



## SOAPSTONE HOLDERS

- Soapstone features highly visible white marking stick cut from natural stone which adheres to metal, stone, concrete and fabrics
- Soapstone holders feature a pocket clip
- Sold with one soapstone installed
- Replacement soapstones available

### ROUND HOLDER:

- Aluminum adjustable holder for 1/4" x 5" soapstone or chalk

### FLAT HOLDER:

- Steel adjustable holder for 1/4" x 5" flat soapstone or chalk

Model No.	Description
NT638	Round Holder
NT639	Flat Holder



## WELDING STARTER'S KIT

- 2" x 4-1/4" or 4-1/4" x 5-1/4" lightweight welding helmet, with shade 10 lens and ratchet headgear
- Cotton welder's beanie, one size fits all
- Welding gloves, split leather with full thermal lining
- Chipping hammer, cone and chisel head with spring steel handle
- MIG pliers, 8-way with nickel plated finish
- Safety glasses with adjustable temples

Model No.	Description
TTU300	Kit With 2" x 4-1/4" Helmet
TTU301	Kit With 4-1/2" x 5-1/4" Helmet



## SHORTSTUB™ ELECTRODE HOLDERS



- Grip the electrode closer to the end
- Allows you to use 20% more of the electrode than with standard tong holders
- Manufactured from copper alloy for maximum conductivity and strength
- Fibreglass insulators are designed to withstand intense heat and impact
- Will not burn, break or carbon char

Model No.	Amps	Description
NT629	400	Electrode Holder w/ Neck Ring
NT631	600	Electrode Holder w/ Neck Ring
NT630	400	Slimline – Bernard® Style Holder
NT818	-	Replacement Head For <b>NT629</b> & <b>NT630</b>
TTV098	-	Replacement Head For <b>NT631</b>



## STANDARD GROUND CLAMPS

- Manufactured from nickel-plated steel with forged brass conductors
- Heavy-duty springs provide positive strength at jaws
- **NT661** is ideal for farm welder and light shop work; current flows directly from lower jaw to welding cable
- **NT662** is ideal for portable gas drive welders; braided strap carries current to both upper and lower jaws, fully insulated hinge and spring prevents arcing

Model No.	Amps
NT661	300
NT662	500

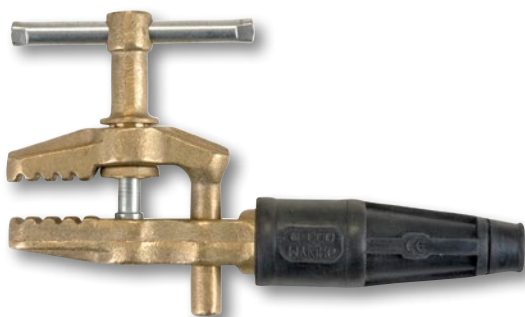

## HEAVY-DUTY "C-STYLE" GROUND CLAMP

- C-type jaws are adjusted by screw lever
- Rubber insulated cable connector

Model No.	Amps
NT665	600



## HEAVY-DUTY GROUND CLAMPS

- Manufactured from heavy-duty nickel-plated steel with forged brass conductors and braided copper strap to carry current to upper jaw
- Heavy-duty spring provides positive contact at jaws
- Cable is easy to install with built-in cable connector and oval point screw
- Allen-type wrench included

Model No.	Amps
NT668	300
NT669	500

## BRASS GAUGES

- Brass casing
- Lexan™ cover lens
- 1/4" NPT inlet
- Dial type: Analogue
- Connection: Bottom Mount



Model No.	Description
NT616	2" x 100 PSI
NT617	2" x 200 PSI
NT618	2" x 30 PSI – Red Line
NT619	2" x 400 PSI
NT620	2" x 4000 PSI

Model No.	Description
NT622	2-1/2" x 200 PSI
NT623	2-1/2" x 30 PSI – Red Line
NT624	2-1/2" x 400 PSI
NT625	2-1/2" x 4000 PSI

## TIP-NIP TIP REFAKER

- For easy, fast precision tip resurfacing
- Insert tip and give a few turns
- Pitted tip is resurfaced for new performance
- Extends tip life

Model No. NT820



## TIP DRILL KIT

- Cleans welding tips and a variety of other fuel orifices and injectors
- Includes 10 drills in sizes 52-74
- Promotes more effective fuel use and increases performance in welding, cutting and heating tips
- Drills store neatly in pipe vise handle

Model No. NT660



## SPIRAL TIP CLEANER

- Cleaning data on back of case
- Hardening steel file included in each case
- Standard or extra long King set
- Quality aluminum case
- Includes: 12 cleaners



Model No.	Description
NT641	Standard Set
TTV223	King Set

## FLINT LIGHTERS

- Choice of single or three flint lighters
- Additional flints sold separately

Model No.	Description
NT642	Single Flint Lighter
NT663	Flints, 5 per Holder
TTU071	Three Flint Lighter
TTU072	Flints
TTU432	Single Flint Lighter, With 5 Flint Holder

NT642



TTU071



NT663



TTU072

## CABLE PROTECTOR

- Durable leather with Kevlar® sewn seams
- Lightweight to enhance flexibility and strength
- Metal snaps every 3"
- For TIG, MIG, plasma and flux-cored torch cable/hose assembly
- 4" W x 22" L

Model No. NP520



## PYTHONRAP™ CABLE COVER

- Nylon cover
- Full length zipper
- 4" W x 22" L

Model No. NT887



## ROD HOLDER

- Double leather bottom and metal swivel clip
- 5-ply Kevlar® stitched with rivet reinforcement
- Holds electrodes up to 15"

Model No. NP519



Rods not included

## MAGNETIC HOLDERS

- Multi-purpose holders for assembly and positioning
- Adheres to any metal object
- Ideal for welding, soldering, assembly, pipe installation



Model No.	Description	Dimensions L' x W' x H'
NT626	Medium	5 x 3.25 x 0.5
NT627	Large	6.25 x 4 x 0.75
NT628	X-Large	8 x 5 x 1

## INDUSTRIAL DUTY SCRATCH BRUSHES

- Wood handle
- Choice of carbon or stainless steel bristles

Model No.	Bristles	Length of Brush"	Overall Length"	Trim Length"	Rows
<b>LONG HANDLE BRUSHES</b>					
NT607	Carbon Steel	5-3/4	13-3/4	1	3 x 19
NT608	Carbon Steel	5-3/4	13-3/4	1	4 x 19
NT611	Stainless Steel	5-3/4	13-3/4	1	3 x 19
NT612	Stainless Steel	6	10-1/4	1	4 x 19
<b>SHOE HANDLE BRUSHES</b>					
NT609	Carbon Steel	5-1/4	10-1/2	1	3 x 16
NT610	Carbon Steel	5-1/4	10-1/2	1	4 x 16
NT613	Stainless Steel	5	10-1/2	1	3 x 16
NT614	Stainless Steel	5	10-1/4	1	4 x 16
<b>"TOOTHBRUSH" CLEANING BRUSH</b>					
NT615	Stainless Steel	1-1/2	7-3/4	1/2	3 x 7



## AIR CARBON ARC GOUGING TORCH

- For gouging, cutting, beveling, piercing and flushing metal
- Economical air carbon-arc cutting process
- Can be used on most metals
- Chemical changes are virtually nil, as the process is primarily physical

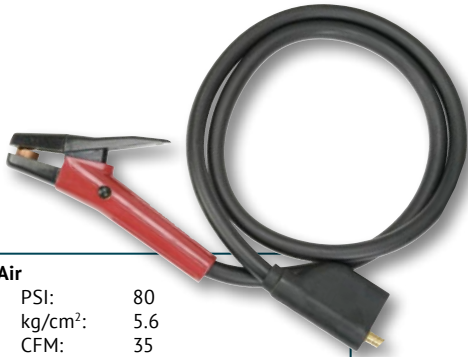

Model No.	Amps
NT667	800

### Air

PSI:	80
kg/cm <sup>2</sup> :	5.6
CFM:	35
CMM:	0.076

### Compressor

Intermittent:	5 HP (3.73 KW)
Continuous:	7.5 HP (5.60 KW)

## AIR REQUIREMENTS

Ordinary compressed air as supplied by a shop airline or compressor is suitable. Most applications require 80-100 PSI.

## AIR CARBON ARC GOUGING ELECTRODES

- Consistent copper coating DCCC
- Used for gouging out defective welds and cutting non-ferrous metals
- Electrodes are 12" in length
- Sold per package

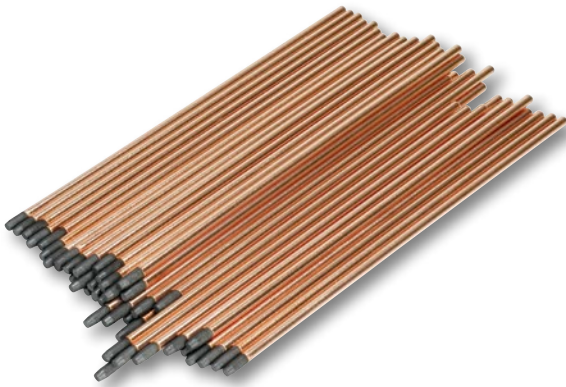

Model No.	Dia."	Qty/Pkg
NT632	5/32	100
NT633	3/16	50
NT634	1/4	50
NT635	5/16	50
NT636	3/8	50
NT637	1/2	50



## CHIPPING HAMMER

- Cone and chisel head
- Spring steel handle
- Head length: 6-1/4"
- Overall length: 10-1/2"

Model No. NP532



## MIG NOZZLE REAMERS

- Cleans hot MIG nozzle on the torch
- Self adjusting to fit all size nozzles
- Expanding spring steel cleaner

Model No. TTU660



NP537



NT666

## MULTI-PURPOSE MIG PLIERS

- Eight-way pliers
- Nickel plated finish
- Ideally suited for removal of hot spatter from nozzle ends, as well as many other use

Model No.	Description
NP537	Pliers
TYX128	Premium Pliers
NT666	Holster for Pliers



## CUTTING TIP CHART

Material Thickness	1/8	1/4	1/2	3/4	1	1-1/2	2	4	5	6	8	10	12
Recommended Tip Number	00	0	1	1	2	2	3	3	4	6	6	7	8
And Drill Size	68	60	56	56	54	54	52	49	44	38	31	28	
Oxygen Pressure Setting lb/in <sup>2</sup> g	20-25	25-30	30-35	30-35	35-40	40-45	40-45	40-50	45-55	45-55	45-55	45-55	45-55
Acetylene Pressure Setting lb/in <sup>2</sup> g	3-5	3-5	3-5	3-5	3-7	3-7	5-10	5-10	6-12	7-13	8-14	10-15	10-15
Cutting in/min	27-30	26-29	20-24	17-21	14-18	13-17	12-15	8-11	7-9	6-8	5-6	4-5	3-4

### AIRCO® 144/ALC 802 STYLE CUTTING TIPS

- For general, hand or machine cutting
- Acetylene-oxygen
- Medium preheat
- Fits Airco® 3790, 4690, 4700, 4800, 5700, 5800, 1100, 3000, 9000 and 9500 style torches

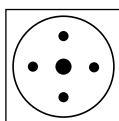

Model No.	Size
TTU465	00
TTU466	0
TTU467	1
TTU468	2
TTU469	3
TTU470	4

### AIRCO® 164/ALC 803 STYLE CUTTING TIPS

- For general, and cast iron or stainless steel cutting
- Acetylene-oxygen
- Very high preheat
- Fits Airco® 3790, 4690, 4700, 4800, 5700, 5800, 1100, 3000, 9000 and 9500 style torches

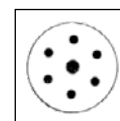

Model No.	Size
TTU471	00
TTU358	0
TTU359	1
TTU360	2
TTU361	3
TTU362	4
TTU472	5
TTU473	6
TTU474	7

### AIRCO® 261/ALC 829 STYLE CUTTING TIPS

- For general cutting, two-piece tip for hand cutting
- Propane or oxygen-natural gas
- High preheat
- Fits Airco® 2900, 3790, 4690, 4700, 4800, 5700, 5800, 1100, 3000, 9000 and 9500 style torches

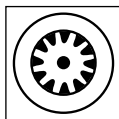

Model No.	Size
TTU475	0
TTU476	1
TTU477	2
TTU478	3
TTU479	4
TTU480	5

### PUROX® 4202/ESAB STYLE CUTTING TIPS

- For general cutting
- Acetylene-oxygen
- Medium preheat
- Fits CW-200, CW-202, CW-300, Type E torches, and C-205 machine torch

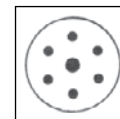

Model No.	Size
TTU481	3
TTU482	4
TTU483	5
TTU484	7
TTU485	9

### SMITH® MC12 STYLE CUTTING TIPS

- Hand cutting with oxy-acetylene
- Medium preheat
- Fits Smith® cutting assemblies MC505, MC509, AC305, and AC309

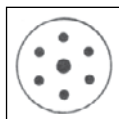

Model No.	Size
TTU530	1

### SMITH® SC12 STYLE CUTTING TIPS

- Hand or machine cutting with oxy-acetylene
- Medium preheat
- Fits Smith® cutting attachments SilverStar & MC40
- Fits Smith® cutting torches Tuf Tony & Silver Star
- Fits Smith® machine torches SC770, SC771, SC780A, SC781A, & SC782A

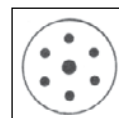

Model No.	Size
TTU531	1

## HARRIS® 6290 STYLE CUTTING TIPS

- For general hand cutting
- Acetylene-oxygen
- Medium preheat
- Fits Harris® 42-3, 62-3, 72, 72A, 73,73A and 85 style torches

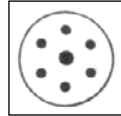

Model No.	Size
TTU458	000
TTU459	00
TTU349	0
TTU350	1
TTU351	2
TTU352	3
TTU460	4
TTU461	5
TTU462	6

## VICTOR® 1-101 STYLE CUTTING TIPS

- For general cutting
- Acetylene-oxygen
- Machine preheat for hand and machine cutting
- Fits 2460, CA 1060, ST, SST, 1400C machine torches

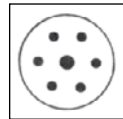

Model No.	Size
TTU441	000
TTU333	00
TTU334	0
TTU335	1
TTU336	2
TTU337	3
TTU338	4
TTU339	5
TTU442	6
TTU443	7
TTU444	8

## VICTOR® GPN STYLE CUTTING TIPS

- For general cutting
- Propane or oxygen-natural gas
- Medium preheat for hand and machine cutting
- Fits 2450, CA 1060, CAN 1060, ST, SST, STN, 1400C machine torches

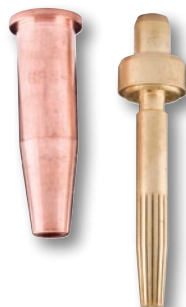

Model No.	Size
TTU452	00
TTU344	0
TTU345	1
TTU346	2
TTU347	3
TTU348	4
TTU453	5

## HARRIS® 6290-NX STYLE CUTTING TIPS

- For general hand cutting
- Propane or oxygen-natural gas
- Medium preheat
- Fits Harris® 42-3, 49AF, 49F, 62-3, 72, 73, 85, and 142 style torches

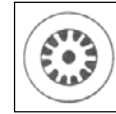

Model No.	Size
TTU463	000
TTU353	0
TTU354	1
TTU355	2
TTU356	3
TTU357	4
TTU464	5

## VICTOR® 3-101 STYLE CUTTING TIPS

- For general cutting
- Acetylene-oxygen
- Medium preheat hand cutting
- Fits CA 1260, CA 1350, C 1450, CA 2060, CST 800, C 1400 torches

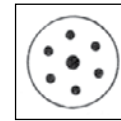

Model No.	Size
TTU448	000
TTU449	00
TTU340	0
TTU341	1
TTU342	2
TTU343	3
TTU450	4
TTU451	5

## VICTOR® 1-118 STYLE CUTTING TIPS

- For gouging
- Acetylene-oxygen
- Gouging, scarfing and deseaming
- Fits 2460, CA 1060, ST and SST, 1400C torches

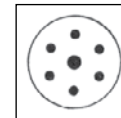

Model No.	Size
TTU445	2
TTU446	4
TTU447	6

## VICTOR® 3-GPN STYLE CUTTING TIPS

- For general cutting
- Propane or oxygen-natural gas
- Medium preheat series 3 tip
- Fits CA 1260, CA1350, C 1450, CA 2060, CST 800, C 1400 torches



Model No.	Size
TTU454	0
TTU455	1
TTU456	2
TTU457	3

# SCN 40

ANS YEARS 1978-2018

Phone: 1-877-807-7772 Fax: 1-877-807-7775

Visit: [www.scnindustrial.com](http://www.scnindustrial.com)

E-mail: [info@scnindustrial.com](mailto:info@scnindustrial.com)

[www.aurora-tools.com](http://www.aurora-tools.com)



Catalogue A1118

CANADA		POSTES
POST		CANADA
	Postage paid Personalized Mail	Port payé Courrier personnalisé
7200955		